



**B R O A D C A S T**

**AUDIO**

**E Q U I P M E N T**

*for*

**AM · FM · TELEVISION**

—  
**(THIRD EDITION)**

**MICROPHONES**

**CONSOLES**

**CUSTOM EQUIPMENT**

**AMPLIFIERS**

**RACK EQUIPMENT**

**TURNTABLES**

**RECORDERS**

**SPEAKERS**

# BROADCAST AUDIO EQUIPMENT CATALOG

(Third Edition)

PRICE \$1.00



BROADCAST AND TELEVISION EQUIPMENT DEPT.

**RADIO CORPORATION OF AMERICA**

Commercial Electronic Products

Camden, N. J.

	Page
<b>Microphones</b>	<b>5</b>
<b>Consolettes</b>	<b>31</b>
<b>Amplifiers</b>	<b>43</b>
<b>Rack Equipment</b>	<b>65</b>
<b>Turntables</b>	<b>81</b>
<b>Tape Recorders</b>	<b>92</b>
<b>Speakers</b>	<b>96</b>
<b>Intercom</b>	<b>113</b>
<b>Test Equipment</b>	<b>120</b>
<b>Index</b>	<b>131</b>

## **ABOUT THIS CATALOG**

This Catalog is devoted solely to information on RCA audio equipment designed especially for broadcast station use. Other RCA Broadcast Equipment Catalogs contain similar information on TV camera, film, and terminal equipment, test equipment, AM, FM and TV transmitters, antennas, transmission line equipment and accessories.

The information contained in this catalog is intended to serve as a buying guide for the users of this type of equipment. In the belief that broadcast engineers want facts, rather than generalities, the content has purposely been kept brief and factual. Readers who desire more information or individual bulletins on particular equipment items are invited to write to the RCA Broadcast Representative in the RCA Regional Office nearest them (see opposite page).

## **OTHER RCA TECHNICAL PRODUCTS**

The RCA equipment described in this catalog is specifically designed for broadcast station and closed circuit use. In similar manner RCA builds electronic equipment for many other industries. These include: two-way radio and microwave relay communications equipment; a complete line of equipment for theatres; optical and magnetic film recording equipment; sound systems of all types; 16mm projectors and magnetic recorders; high-fidelity components for home music systems; industrial inspection equipment; scientific equipment, such as the electron microscope; industrial television systems; intercoms; tape recorders; TV Eye; Antenaplex systems; and many types of custom-built equipment for industry and the military services. Information, and catalogs or bulletins, describing these may be obtained from RCA Regional Offices.

# HOW TO ORDER

The RCA Broadcast Audio Equipment shown in this catalog is sold directly through RCA Broadcast Representatives, who are familiar with broadcast equipment and related problems. One or more of these RCA Representatives are

located in each of the RCA Regional Offices listed below. Orders for equipment shown in this catalog, or requests for additional information, should be directed to the nearest one of these offices.

## PRICES

The prices of the various equipment units shown in this catalog are given in a separate price list. Prices are listed in the order in which they are shown in the catalog. To determine the price of any equipment first note the page

on which it is shown in the catalog, then consult the price list in accordance with this page number. Equipments are identified by type and MI (Master Item) numbers which are used to identify apparatus on invoices and packing slips.

YOU CAN LOCATE YOUR NEAREST RCA REPRESENTATIVE FROM THIS LIST

## REGIONAL OFFICES

Front & Cooper Streets  
CAMDEN 2, NEW JERSEY  
Woodlawn 3-8000

•

36 West 49th Street  
NEW YORK 20, NEW YORK  
Judson 6-3800

•

P. O. Box 35025, Airlawn Station  
(7901 Freeway #183)  
DALLAS 35, TEXAS  
Fleetwood 2-3911

•

1600 Keith Building  
CLEVELAND 15, OHIO  
Cherry 1-3450

2301 John Hancock Building  
200 Berkeley Street  
BOSTON 16, MASSACHUSETTS  
Hubbard 2-1700

•

522 Forsyth Building  
Forsyth and Luckie Streets, N.W.  
ATLANTA 3, GEORGIA  
Jackson 4-7703

•

1006 Grand Avenue  
KANSAS CITY 6, MISSOURI  
Harrison 1-6480

•

1560 North Vine Street  
HOLLYWOOD 28, CALIFORNIA  
Hollywood 9-2154

420 Taylor Street  
SAN FRANCISCO 2, CALIFORNIA  
Ordway 3-8027

•

1186 Merchandise Mart Plaza  
CHICAGO 54, ILLINOIS  
Delaware 7-0700

•

1625 K Street, N.W.  
WASHINGTON 6, D. C.  
District 7-1260

•

2250 1st Avenue, South  
SEATTLE 4, WASHINGTON  
Main 8350

*M/S Engman*



# RCA MICROPHONES

## General Information

The excellence of RCA microphones is the result of continued effort on the part of Engineering and Production personnel to produce a superior product. Out of this work have come the several types of broadcast microphones listed in the catalog. There is considerable overlap in the applications of the various types, but each does possess certain attributes which make it particularly well suited to some specific applications. These have been noted for each microphone in the catalog in order to assist in the selection of the microphone best suited for the intended application.

## High Quality Broadcast and Television Microphones

Broadcast-type microphones such as the Types BK-5A, 77-DX and BK-1A all have certain common performance criteria which make them especially suited to this application. They have smooth response-frequency characteristics over the audio range, low distortion, high output levels, well-shielded output transformers to prevent hum pickup, and where necessary, are shock mounted to reduce the pickup of low frequency building rumble. Performance features which are unique to each particular type are listed and the applications discussed in the catalog.

## Public Address Microphones for Broadcast Use

Public Address Microphones have been designed as economy microphones. In general, frequency range and sensitivity have been sacrificed to some extent in order to gain ruggedness and lower cost. The response limitations should be borne in mind when these microphones are used in Broadcast applications.

## Unloaded Transformer Input

RCA Broadcast Microphones are designed to work into a microphone preamplifier whose input transformer is unloaded. Under this condition of operation the voltage appearing at the grid of the first tube results in a gain in signal-to-noise ratio of between 3 and 6 db as compared with a matched resistance load. The exact value will depend on whether the major source of thermal noise is in the microphone amplifier or in the microphone.

## Microphone Resistance Loading

Microphones in which the moving system is highly damped will in general have their frequency response characteristics little changed by electrical loading. The BK-1A and 77-DX (in the pressure position) are examples of this.

Microphones which show output impedance variations with respect to frequency will have their response characteristics adversely affected by resistance loading. The Type BK-5A, and 77-DX (in the bi-directional and uni-directional positions) are examples of this. Resistance loading of these microphones will generally result in a loss in low frequency response.

## 150 Ohms vs. 250 Ohms

When microphones are connected to unloaded input transformers, impedance matching is not a consideration and the effects of connecting microphones with an output impedance of 150 ohms to a microphone amplifier designed to operate from a 250 ohm source and vice versa will usually be of small consequence. The effect on the level is shown in the tabulation below.

Mic. Output Impedance	Level Change db	
	250	150
250	0	+2.2
150	-2.2	0
Amp. Input Designation	250	150

In addition there will be some change in the overall response-frequency characteristic of the system below 100 cycles and above 5000 cycles, the magnitude depending on the connection and the design of both the microphone and the amplifier input transformer. Variations in response with the usual broadcast quality microphone amplifiers will in most cases not exceed  $\pm 2$  db.

When microphones are connected to a resistance load the following changes in level will result when the output is referred to a matched condition.

Mic. Output Impedance	Level Change db	
	250	150
250	0	-2.5
150	+2.0	0
Load Impedance	250	150

## Microphones Shipped Less Plug

RCA microphones are supplied less the plug for connection to the wall outlet or amplifier system. This is done to allow the user to select any desired plug. As a convenience four types of Cannon plugs are catalogued and they may be ordered as an accessory if wanted.

## Microphone Mounting

RCA has standardized on the rugged  $\frac{1}{2}$ " pipe thread for broadcast microphone mounting. This size thread makes it easy to add microphone stand extensions, booms, etc., for they may be easily made up locally from standard  $\frac{1}{2}$ " pipe and fittings. Most of the stands listed may also be used with microphones having a  $\frac{3}{8}$ "-27 thread by removing an adapter which is supplied as a part of the stand. Various adapters are available for microphones should the use of the  $\frac{1}{2}$ " pipe thread prove inconvenient.

### Effective Output Level

When a microphone is connected to an unloaded input transformer its power output cannot be expressed in dbm because no appreciable power is delivered by the microphone. The logical approach to the problem is to arrive at some level figure which, when combined with the conventionally measured amplifier gain, will give the correct output level for the combination. This figure is listed in the catalog for each microphone and is called the Effective Output Level. It differs from the RETMA standard rating  $G_M$  in the value of sound pressure and source impedance. The RETMA rating computation is based on a source impedance of 150 ohms for all microphones having output impedances between 75 and 300 ohms, and on a sound pressure of 0.0002 dynes per square centimeter.

The Effective Output Level calculation is based on the nominal microphone impedance and on a sound pressure of 10 dynes/cm<sup>2</sup>.

The RETMA standard defines the system rating ( $G_M$ ) of a microphone as the ratio in decibels relative to 0.001 watt per 0.0002 dynes per square centimeter of the maximum electric power available from the microphone to the

square of the undisturbed sound field pressure in a plane progressive wave at the microphone position. Expressed mathematically:

$$G_M = (20 \log_{10} \frac{E}{P} - 10 \log_{10} R_{MR}) - 50 \text{ db.}$$

- where E = the open circuit voltage of the microphone
- P = the undisturbed sound field pressure
- $R_{MR}$  = the microphone rating impedance
- Electrical reference level = .001 watt
- Sound pressure = .0002 dynes/sq. cm.

While this may look complex the application is simple. For all practical purposes the output level of the microphone is obtained by adding to  $G_M$ , the sound pressure level relative to 0.0002 dynes per square centimeter. The sound pressure level of the program material can be measured with any of the several available sound level meters.

### Hum Pickup Level

An arbitrary standard 60 cycle a-c field of 10<sup>-3</sup> gauss has been established as a reference. It is fairly representative of fields measured at typical microphone locations in broadcast studios. The hum level is referred to .001 watt and is calculated in the same fashion as the Effective Output Level, using as the output voltage the voltage produced by the standard field.

**Chart Showing Microphone Applications, Chief Characteristics and Recommended Mounts**

Type No.	Use <sup>3</sup>	Directional Characteristic	Effective Output Level <sup>1</sup> and $G_M$ <sup>4</sup>	Output Impedance Ohms	Frequency Response cps	Hum Pick-up Level <sup>2</sup>	Finish	Stand
77-DX	Program Announce	Poly-directional	-53 dbm $G_M$ -147 db	30/150 250	50-15,000	-128 dbm	Satin Chrome & TV Gray	Boom, Desk, Floor
BK-1A	Program Announce	Non-directional	-53 dbm $G_M$ -145 db	30/150 250	60-10,000	-109 dbm	Satin Chrome & TV Gray	Desk, Floor
BK-5A	Program Announce	Uni-directional	-56 dbm $G_M$ -150 db	30/150 250	50-15,000	-128 dbm	TV Gray	Boom, Desk, Floor
BK-6B	"Off-Mike" Speech	Semi-directional	-67 dbm $G_M$ -158 db	30/150 250	80-12,000	-112 dbm	TV Gray	Clip & Microphone Lanyard
SK-35	Sports Announce	Bi-directional	-58 dbm $G_M$ -150 db	200/15,000	50-10,000	-113 dbm	Satin Chrome & TV Gray	Hand, Desk, Floor
SK-45	Intercom & Talkback	Non-directional	-56 dbm $G_M$ -149 db	200/15,000	80-8,000	-109 dbm	TV Gray	Desk, Floor
SK-46	Radio & TV Announce	Bi-directional	-58 dbm $G_M$ -150 db	200/15,000	50-10,000	-113 dbm	Satin Chrome & TV Gray	Hand, Desk, Floor

<sup>1</sup> Reference level 0.001 watt, sound pressure 10 dynes per square centimeter. This corresponds to a rating by the proposed RETMA system at a sound pressure level of 94 db.

<sup>2</sup> Level referred to a hum field of 10<sup>-3</sup> gauss.

<sup>3</sup> For details refer to description of each particular type.

<sup>4</sup>  $G_M$  = (RETMA rating).

<sup>5</sup> Also available in TV Gray as MI-11006-C.



# POLYDIRECTIONAL MICROPHONE

## TYPE 77-DX

### FEATURES

- High quality reproduction with greater sensitivity over entire audio frequency range
- Styled for either radio or TV applications
- Choice of directional pattern to control ratio of direct-to-reverberant sound pickup
- Three-position voice-music switch allows selection of best operating characteristic
- Efficient shock mounting

### USES

The RCA Type 77-DX Polydirectional Microphone is primarily intended for broadcast use either in the radio or television studio. Two models are available. The MI-4045-F finished in satin chrome and a low-gloss umber gray enamel is intended for AM or FM stations, while the MI-11006-C microphone is intended for television use and is therefore completely finished in a low-gloss umber-gray enamel which eliminates glaring reflections. Both instruments are high-fidelity microphones of the ribbon type which may easily be adjusted to obtain a variety of directional patterns. If used outdoors the Type 77-DX may require some additional protection against the wind.

As a uni-directional microphone the 77-DX has a wide pick-up angle on front which may be used to advantage as a general programs and announce studio microphone and for television boom operation. It is recommended for use on programs where it is desirable to cover a large area with a single microphone, on programs where studio acoustics are more live than optimum, and programs where it is desirable to eliminate audience noise originating behind the microphone. The 77-DX can also serve as a bi-directional instrument in place of the SK-46 microphone on programs where the players are grouped around the microphone or are seated on opposite sides of a table. In the non-directional position, the microphone is excellent for announce work or for out-door locations.

### DESCRIPTION

The RCA Type 77-DX Polydirectional Microphone operates as a uni-directional, bi-directional or non-directional instru-



MI-11006-C

MI-4045-F

ment by positioning of a shutter to secure various areas of opening. The moving element is a thin corrugated metallic ribbon clamped at the ends and suspended in the air gap of a magnetic circuit consisting of an Alnico V permanent magnet and pole pieces. One side of the ribbon is open and the other is connected by means of a tube to a folded acoustically damped pipe contained in the center section of the microphone.

The tube connecting the back of the ribbon to the labyrinth is slotted directly behind the ribbon and fitted with the shutter which controls the directional properties of the microphone. When the opening is completely closed, the microphone operates as a non-directional pressure microphone; at the wide-open position the instrument becomes bi-directional. With the proper size opening the pattern becomes a cardioid by virtue of the phase shift which occurs. Openings smaller or larger than this critical size produce directional patterns with various sized rear lobes. Different amounts of low-frequency attenuation are obtained by a reactor shunting the output.

The shutter opening is operated by turning a slotted shaft which is brought out flush with the rear of the windscreen.

The shutter position is indicated on a plate mounted on the screen and marked "U", "N" and "B". Three additional markings "L-1", "L-2", and "L-3" are used as reference points for other directional patterns which may be obtained. If desired, the microphone may be locked in the uni-directional position by means of a cover plate marked "U". This fastens over the indexed plate. The bottom portion of the microphone contains an impedance matching transformer and switch for selecting response characteristics for voice or music. The switch shaft is slotted and accessible through a hole in the bottom of the lower shell. The transformer is exceptionally well shielded against stray magnetic fields.

The 77-DX will mount on any stand having a 1/2-inch pipe thread. Other stands will require a suitable adaptor. The microphone is cushion-mounted, and a fork mounting is provided so that the instrument may be fitted to the desired position. The microphone is connected for an output impedance of 250 ohms at the factory, but it may be adjusted for an output impedance of 30 or 150 ohms.

**SPECIFICATIONS**

- Directional Characteristics.....Adjustable, 6 positions (see curves)
- Output Impedance.....250 ohms, may be changed to 30 or 150 ohms
- Load Impedance.....Unloaded input transformer
- RETMA System .....GM
- Effective Output Level (all output connections):
  - Bi-directional.....-50 dbm\* GM = -144 db
  - Uni-directional.....-53 dbm\* GM = -147 db
  - Non-directional.....-56 dbm\* GM = -150 db
- Hum Pick-up Level.....-128 dbm\*\*
- Dimensions (overall).....11 1/2" long, 3 3/4" wide, 2 1/4" deep
- Weight:
  - Microphone .....3 lbs.
  - Cable .....1 1/2 lbs.
- Cable (MI-43-B, 3 conductor, shielded).....30 ft., no plug
- Mounting.....1/2" pipe thread
- Stock Identification:
  - Satin Chrome .....MI-4045-F
  - TV Gray .....MI-11006-C

**Accessory**

- Protective Cloth Bag.....MI-4087

\* Sound Pressure = 10 dynes/cm<sup>2</sup>.  
 \*\* Referred to a hum field of 1 x 10<sup>-3</sup> gauss.

Typical Directional Patterns and Frequency Response Curves of 77-DX Polydirectional Microphone



Rear view of 77-DX Microphone

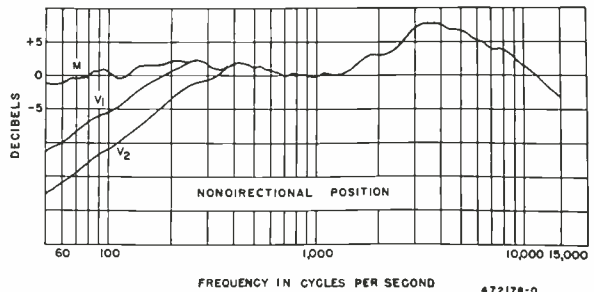
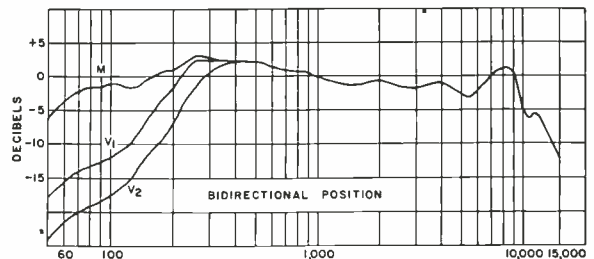
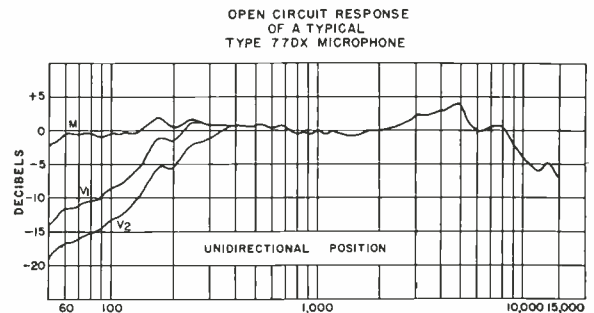
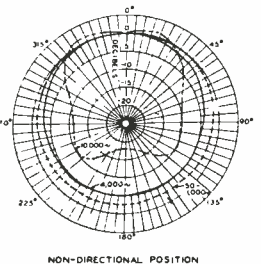
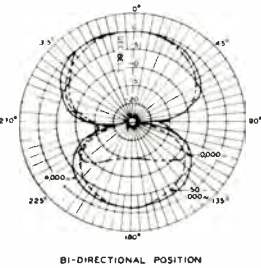
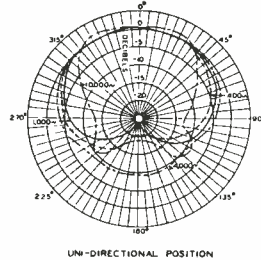

FREQUENCY IN CYCLES PER SECOND 472178-0



# PRESSURE MICROPHONE

## TYPE BK-1A



### FEATURES

- Smooth response over the essential audio frequency range
- Modern styling blends pleasingly with the television scene
- Removable from base for use as hand microphone or for mounting on floor stand
- Adjustable ball and socket swivel allows any desired direction
- Ideal for remote pickups—insensitive to wind and mechanical vibrations
- Non-reflective TV gray finish
- Frequency characteristic independent of source distance
- Light weight—small and portable

### USES

The high-fidelity BK-1A "Commentator" pressure microphone is designed for broadcast use in AM, FM and TV stations. Its construction makes it particularly well suited for remote pickups where, if used in the open air, the modern design practically eliminates the effect of air currents. The BK-1A features a smooth response and frequency range which make it suitable for reproducing both music and speech.

Rugged, insensitive to wind and mechanical vibration, the BK-1A is the ideal microphone for outdoor use where constant handling by the announcer is necessary. Highly styled, it effectively serves TV announce desk or conference programs where each participant has a microphone in the scene.

Characteristics of design and styling make the BK-1A desirable for: broadcasts where the microphone should blend with the scene; programs where the performer must work close to the microphone; and public address system use.

### DESCRIPTION

The BK-1A is a pressure actuated type microphone. The sound pressure actuates a lightweight molded diaphragm attached to an annular coil assembly which is placed within a magnetic field. An acoustic circuit, coupled to the diaphragm, is proportioned so that the diaphragm velocity remains essentially constant for a constant sound pressure from 60 to 10,000 cycles. The coil is connected to an impedance matching transformer providing output impedances of 30, 150, and 250 ohms.

Non-directional when mounted vertically, a semi-directional characteristic is obtained when horizontally mounted, in which case the BK-1A is essentially non-directional for frequencies below 2000 cycles—the higher frequencies attenuated more as the angle with the perpendicular to the diaphragm increases.

Versatility is assured by design which allows the BK-1A to be stand mounted on desk or floor or to be easily removed from the stand mountings for use as a hand microphone. A durable ball and socket joint located at the base of the stem makes selection of the best speaking angle easy, when used as a stand mounted microphone.

**SPECIFICATIONS**

Effective Output Level.....-52 dbm\*  
 Frequency Response.....60-10,000 cycles  
 Output Impedance.....30/150/250 ohms (connected for 250 ohms  
 when shipped)

**RETMA Rating ( $G_M$ ):**

250 Ohms .....-144 db  
 150 Ohms .....-147 db  
 30 Ohms .....-148 db

**Directional Characteristic:**

Semi-directional.....When mounted horizontally  
 Non-directional.....When mounted vertically  
 Recommended Load Impedance.....Unloaded input transformer  
 Hum Pickup Level.....-102 dbm (.001 gauss)  
 Length.....7 $\frac{3}{4}$ " (including mounting)

Diameter .....1 $\frac{7}{8}$ "  
 Weight.....18 oz. (less cable)  
 Cable.....3-conductor shielded, 30 feet (no plug)  
 Stand Fitting..... $\frac{1}{2}$ " pipe thread  
 Finish.....TV gray and chrome  
 Weight of Base.....19 oz.  
 Diameter of Base.....4 $\frac{3}{8}$ "  
 Stock Identification .....MI-11007

**Accessories**

Base, Type KS-11A.....MI-11008  
 Floor Stand .....MI-6208  
 Microphone Cable Plug, Male, Cannon Type.....MI-4630-B

\* Referred to one milliwatt and a sound pressure 10 dynes/cm<sup>2</sup>.

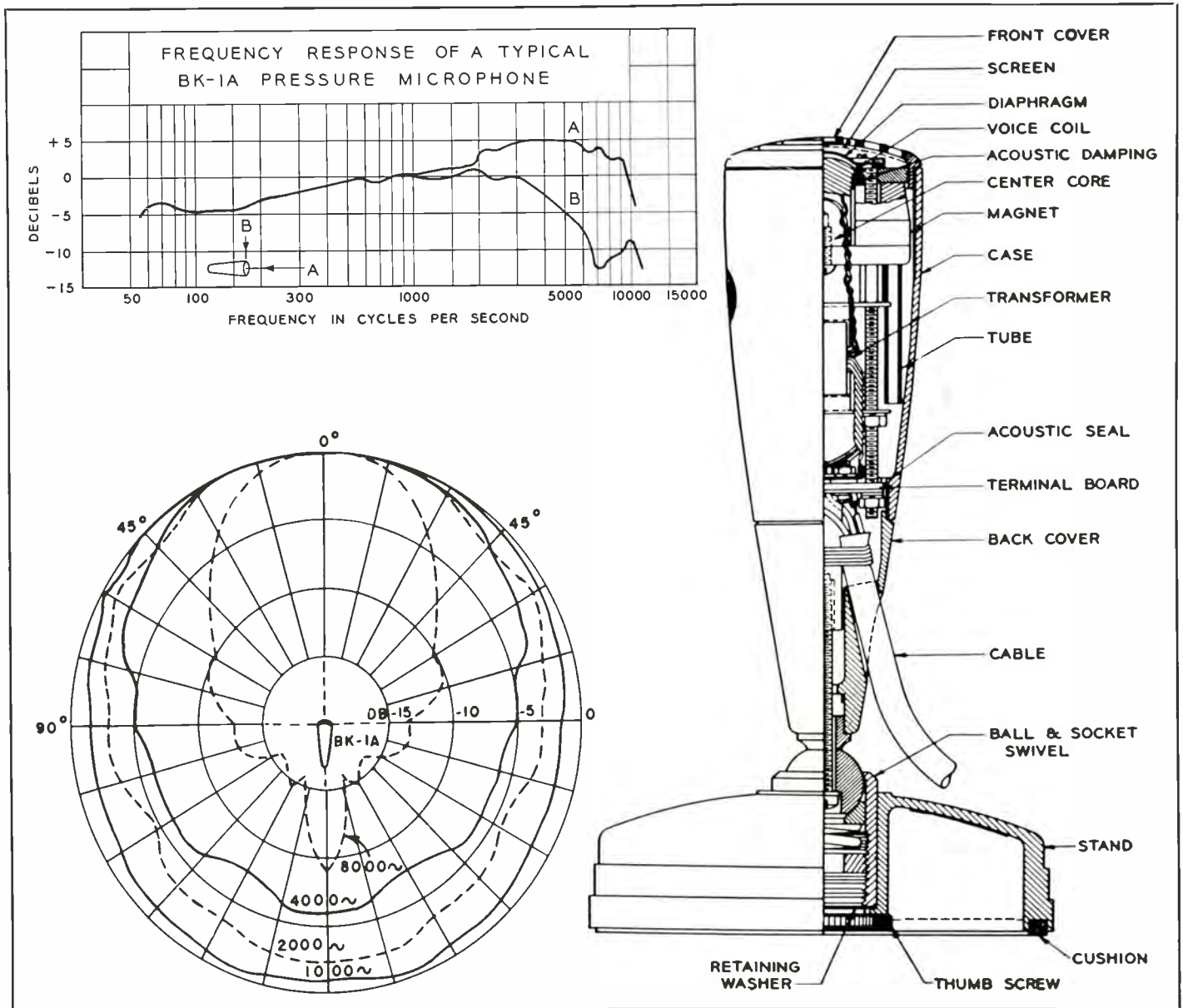

# UNIAXIAL MICROPHONE

TYPE BK-5A

## FEATURES

- High quality reproduction over entire audio frequency range
- Improved unidirectional characteristic with wide pickup angle on front
- Simplifies microphone and camera placement problems—maximum sensitivity lies on major mechanical axis
- Small size—lightweight for TV boom operation
- Rugged construction—improved resistance to gun blasts
- Satisfactory operation in high hum fields because of exceptionally good shielding
- Wind screen for out-doors or fast-panning shots
- No rubber band mountings to replace
- Improved long-life flexible cable



## USES

The RCA Type BK-5A Uniaxial Microphone is a dependable, high-quality ribbon instrument possessing an improved unidirectional characteristic, and designed for broadcast use in AM, FM and TV stations. The microphone has a frequency response that is essentially uniform from 50 to 15,000 cycles. Its smooth response and frequency range make it ideal for reproducing both speech and music.

The microphone has been especially engineered with the television studio in mind. Since maximum sensitivity lies on

the major mechanical axis, it is a one axis, or uniaxial type microphone. This directional characteristic simplifies microphone and camera placement problems. Incorporated in the unit is a blast filter which effectively reduces damage to the microphone from gun blasts and other violent noises. In addition, the small size, light weight, unobtrusive yet attractive TV gray finish and appearance render it especially suitable for television, but it is also admirably suited to general broadcasting and high-fidelity sound systems.



**DESCRIPTION**

The Type BK-5A Microphone is a unidirectional microphone in which the moving element is a thin corrugated metallic ribbon clamped under light tension to cause it to vibrate at its own resonant frequency. The ribbon is placed between the pole pieces of a magnetic circuit. One side of the ribbon is open to the atmosphere and the other opens on an acoustical labyrinth which has phase-shift openings giving the instrument its improved unidirectional characteristics. The labyrinth of the microphone houses an impedance matching transformer and switch for selecting response characteristics for voice or music.

A unique feature of the BK-5A is a blast filter consisting of two separate cloth layers supported by perforated metal screens. The filters effectively reduce damage to the microphone from gun blasts and other violent noises required in broadcast programming. In addition, the transformer is exceptionally well shielded against stray magnetic fields and can perform satisfactorily in high hum fields. As further protection for the sensitive vibrating ribbon a wind screen is available for use with the instrument. Its use is recommended if the instrument is to be used outdoors.

The integration of the blast filter, acoustic phase-shift network and especially designed connector to couple the ribbon to the labyrinth is responsible for the unique uniaxial characteristic of the BK-5A, and uniform frequency response over the entire aural spectrum. The microphone is housed in a tri-sectional casting which blends functions and appearance into a coherent whole. It is supported by a fork mounting which has a 1/8" straight pipe thread to

BK-5A Microphone mounted on Type 91-C Desk Stand. RCA Standard Cushion Mount Adaptor (Stock #93973) is required in this application.



BK-5A Microphone with Wind Screen, MI-11011, and Boom Unit, MI-11012.

fit RCA cushion mountings for either desk or floor stands. An improved shock mount based on panel meter mounts designed for military use is incorporated in the Boom Unit. This new mount isolates the microphone effectively from its support and does not generate any noise. There are no rubber band mountings to wear out and need replacement. A 30-foot flexible cable, supplied with the microphone, makes use of tinned cadmium bronze wire to provide longer life.

The small size and axial directivity aid in placing the BK-5A in inconspicuous fixed locations. There are no shiny external parts to reflect light and draw attention to the instrument. The axial directivity combined with the Boom Mount (MI-11012) make the microphone very easy to handle to keep the sound source "in focus." The addition of the wind screen to this combination does not cause a loss of the sense of the pickup axis.

**SPECIFICATIONS**

**Performance Specifications**

Directional Characteristic .....	Unidirectional
Frequency Response.....	.50 to 15,000 cycles
Output Impedance.....	250 ohms, may be changed to 30 or 150 ohms
Load Impedance.....	Unloaded input transformer
Effective Output Level at 1000 cps.....	-56 dbm
RETMA Rating (GM) (150 ohm connection).....	-150 dbm
*Hum Pickup Level.....	-128 dbm
Cable.....	3-conductor, shielded, 30 feet, no plug
Dimensions (overall).....	7" x 2 3/4" x 2 7/8"
Weight.....	1 pound, 11 ozs. (less cable)
Finish .....	Low-gloss TV gray enamel
Mounting.....	1/8" straight pipe thread (female)
Stock Identification .....	MI-11010

**Accessories**

Boom Unit .....	MI-11012
Wind Screen .....	MI-11011
Cushion Mounting Assembly.....	Stock No. 93973

\* Relative to a field of  $1 \times 10^{-3}$  gauss.



# MINIATURE DYNAMIC MICROPHONE

## TYPE BK-6B

### FEATURES

- RCA's new Personal Miniature microphone only one half the size and weight of BK-6A miniature microphone
- Easily concealed in man's hand . . . in clothing . . . on TV settings
- Methods of mounting . . . by lanyard for placing around neck . . . by clipping to lapel or among corsage . . . mounting beneath necktie
- Excellent speech balance when talking "off-mike"
- Wide-range frequency response
- Rugged construction . . . color and styling makes it blend with surroundings



### USES

The RCA Personal (Type BK-6B) Microphone is especially designed for correct speech balance when used informally in television broadcasting interviews and public address applications. The frequency response and directional characteristics are engineered to complement human speech so that the microphone has excellent balance when the performer is talking "off mike".

The BK-6B may be worn by the performer; its small bulk and neutral color make it inconspicuous. The light weight and flexible cable permit free, unhampered movement of the performers. It may be wholly concealed in a man's hand during an interview, or it may easily be concealed on a set. The styling blends readily with any props, and is pleasing where it is exposed to direct view. It is best used, suspended from the neck, resting on the chest, where it attenuates the low pitched chest sounds while at the same time it points straight up toward the lips, the position in which it is most sensitive to the sibilant sounds that would normally be lost.

### DESCRIPTION

A high quality instrument of the pressure actuated type, the Personal Miniature Dynamic Microphone has a frequency response from 80 to 12,000 cycles and a directional characteristic similar to the popular RCA 77-DX in the nondirectional voice "ONE" position. A special internal acoustic resonator is employed to support the response to lower frequencies and a damped resonator placed in front of the diaphragm reduces high frequency emphasis while extending the upper frequency limit. The result is a pleasing balance for speech when the microphone is used "off mike" or worn on the person.

The microphone as shipped from the factory is connected for an output impedance of 250 ohms. However the impedance may be changed to 30 or 150 ohms by a simple cable connection change. The special plastic motor diaphragm and coil assembly, output transformer and terminal board and bracket assembly are housed in a rugged and practically weather-proof case. The entire microphone

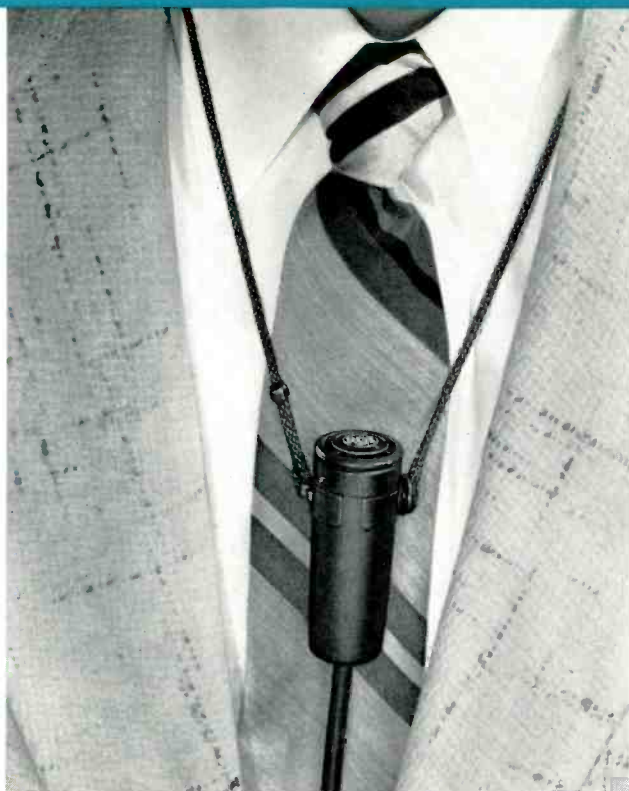

BK-6B Microphone used as a "necktie" mike. May be mounted beneath the necktie or exposed.

is only 2 $\frac{1}{16}$ " long and  $\frac{15}{16}$ " in diameter and weighs but 2.3 ozs., less the cable.

The cable, especially designed for the BK-6B unit, has unusual flexibility combined with long life under conditions of severe abuse. The conductors are of cadmium bronze for high flexibility and long flex life. The shield is carbon-impregnated, conducting cotton overlaid with a light metallic braid. The conducting cotton ensures complete electrostatic shielding and the light, metallic braid keeps the series resistance of the shield low without making the cable excessively stiff. The external jacket of brown Neoprene gives a tough, neutral colored, protective covering to the cable. A lanyard is furnished for mounting the microphone conveniently about the neck.

**SPECIFICATIONS**

Output Impedance.....	250 ohms, can be changed to 30 or 150 ohms
Frequency Response.....	80-12,000 cycles
Directional Characteristics.....	Semi-directional, see chart
Effective Output Level @ 1000 cps.....	-67 dbm (referred to a sound pressure of 10 d/cm <sup>2</sup> )
RETMA Sensitivity Rating.....	-158 db
Output Voltage (open circuit).....	48 mv/d/cm <sup>2</sup>
Hum Pickup.....	-112 dbm (referred to a hum field of 1 mg.)
Cable.....	.30 ft. flexible, two conductor, shielded, no plug
Mounting.....	Removable lanyard for suspending about neck
Overall Dimensions.....	2 $\frac{1}{16}$ " long x $\frac{15}{16}$ " diameter
Weight.....	2.3 ozs., less cable
Finish.....	TV gray
Stock Identification.....	M1-11017

**DIRECTIONAL CHARACTERISTICS**

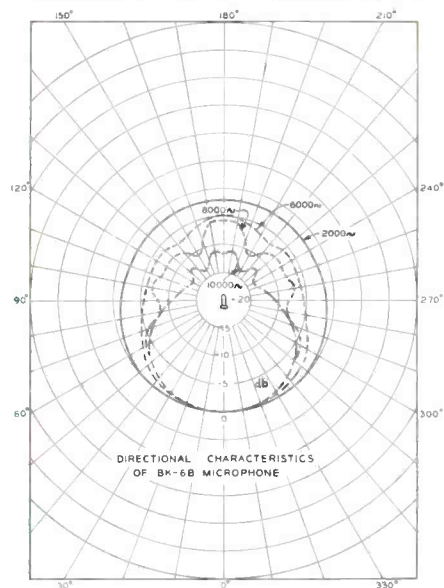

**FREQUENCY RESPONSE CURVE**

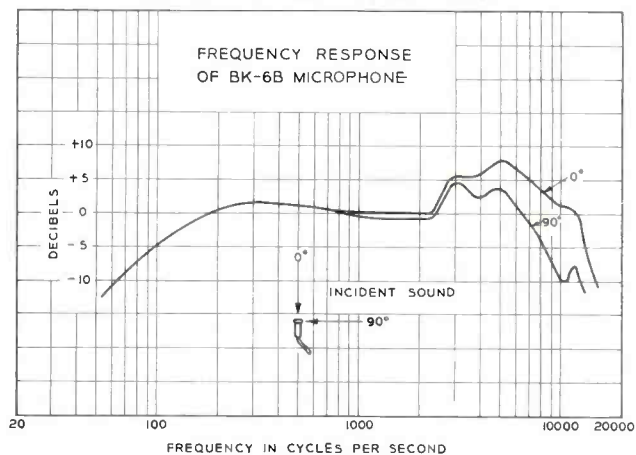

Size is compared to an inch scale . . . also shown is the lanyard with snap fastener for versatile mounting.

# PRESSURE MICROPHONE

## TYPE SK-45

### FEATURES

- Rugged construction
- Economical, light weight, small in size
- Attractive appearance
- High or low impedance
- Dynamic type
- Excellent for announce work
- Swivel mounting

### USES

The MI-12045-A Announce Microphone is suitable for talk-back or cue purposes. It may be used indoors or outdoors where a rugged, light weight microphone with good response to voice is required. It is a "close-talk" microphone.



### DESCRIPTION

This microphone is a pressure operated microphone employing the dynamic principle. The moving element is a thin molded diaphragm in which a single straight wire is embedded. This wire which is held in the airgap of a strong permanent magnet generates a small voltage of the same wave form as the sound acting on the diaphragm. The wire is connected to the primary of a small, but efficient transformer, in order to provide an output voltage sufficiently high to allow the output to be fed directly to the grid of the first input tube. The two conductor shielded cable is connected permanently to the microphone.

The change from high to low impedance (or low to high) is easily accomplished by changing one soldered connection in the head of the microphone.

A swivel arrangement allows tilting of the head forward or back through an arc of approximately 45 degrees each side of the vertical position. New streamlined design, rugged construction and attractive baked TV gray enamel finish makes this microphone a welcome addition to any installation.



SPECIFICATIONS

Directional Characteristics:	
(Below 3000 cycles/sec.).....	Non-directional
(Above 3000 cycles/sec.).....	Semi-directional
Output Impedance.....	200 ohms balanced or 15,000 ohms†
Output Level at 1000 Cycles/sec.:	
Low Impedance .....	-56 dbm
$G_M$ .....	-149 db
High Impedance .....	-59 db*
Hum Pickup Level:	
High Impedance .....	-94 db**
Low Impedance .....	-109 dbm
Frequency Range.....	.75 to 10,000 cycles/sec.
Mounting.....	$\frac{5}{8}$ -27 fixture thread
Dimensions:	
Height (including shank) .....	$5\frac{3}{8}$ "
Width .....	$1\frac{5}{8}$ "
Depth .....	.2"
Finish.....	TV gray enamel
Weight, with Cable.....	1 $\frac{1}{4}$ lbs.
Stock Identification:	
Microphone and Cable (25 feet).....	MI-12045-A

† Stocked with soldered connection to the 200 ohm tap.  
 \* Referred to 1 volt/dyne/cm<sup>2</sup>.  
 \*\* Hum field  $1 \times 10^{-3}$  gauss.  
 0 db = 1 volt.

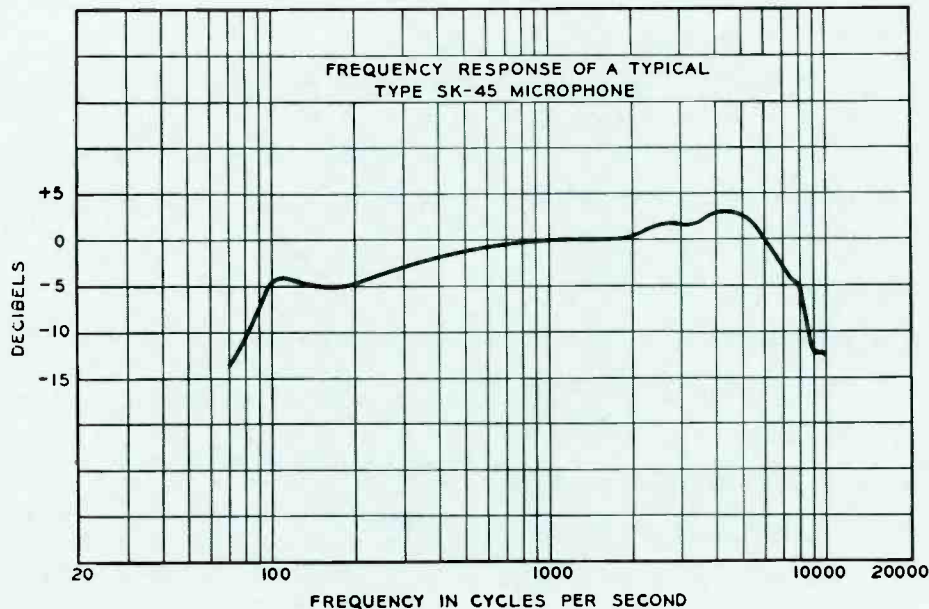
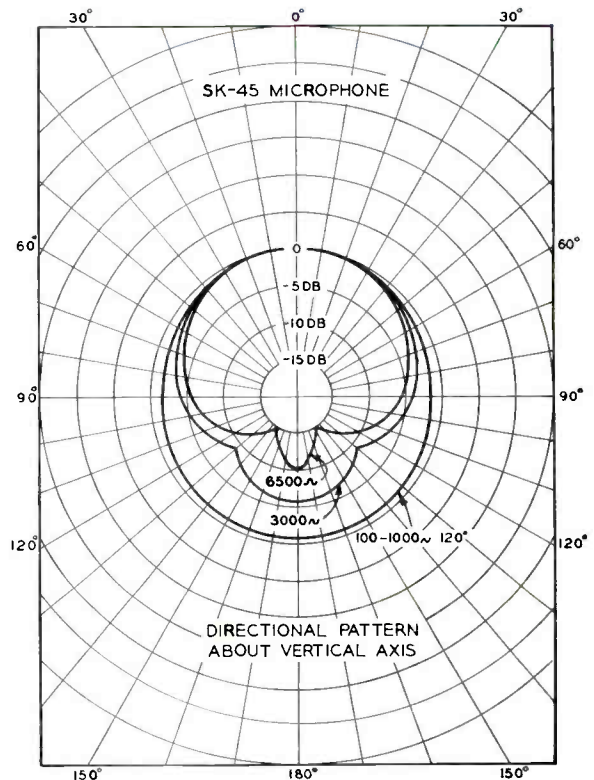



# VELOCITY MICROPHONES

ANTI-NOISE TYPE SK-35 • PROGRAM TYPE SK-46



## FEATURES

- Bi-directional characteristics over wide frequency range
- Light weight, small in size
- Modern styling blends pleasingly with any background
- Adjustable impedance taps
- TV gray and satin chrome finish
- Swivel mounting
- Extremely rugged construction

## USES

The RCA Type SK-35 Anti-Noise and SK-46 Program Velocity Microphones have been designed for AM, FM and TV announcing. Both models are similar physically except that the SK-35 Microphone has internal insulation to adapt it for close announce or program use where it is desirable to attenuate the pickup of extraneous noise. This makes it particularly useful for sports announcements and for use in locations where the announcer can speak within one inch of the microphone. Its insulation makes it especially insensitive to wind and is highly recommended for outdoor use. The SK-46 is designed for indoor use especially for "on stage", announce booth and general program situations.

Both model velocity microphones feature excellent response and directional characteristics and their small size makes them valuable and versatile instruments where quality production of sound is desired. The directional characteristics reduce unwanted acoustical background noise, reflections and feedback. The microphones are virtually shock proof and will take a high degree of abuse without altering performance characteristics.

## DESCRIPTION

The RCA SK-35 and SK-46 are velocity microphones in which the moving element is a thin, corrugated metallic ribbon supported at the ends and placed between the poles of two small powerful magnets in a magnetic circuit. Because of its light weight, the motion of the ribbon corresponds very closely to the velocity of the air particles; therefore, the voltage generated by it is a faithful reproduction of the sound waves that traverse it. The ribbon is connected to the primary winding of a small efficient transformer whose secondary winding matches either 150-250 ohms or high impedance, as required. The change in impedance is easily accomplished by changing one soldered connection inside the microphone.

The excellent frequency response, high output level, absence of excitation due to breath, and anti-feed back characteristics are truly amazing. Above 1000 cycles, the discrimination against random unwanted sound is 19 db better than that obtained with a conventional pressure

**DESCRIPTION (Continued)**

microphone used at a distance of six inches. Below 1000 cycles, background noise discrimination increases to a value of 44 db at 100 cycles. The net result is a high-fidelity anti-noise microphone.

Acoustically designed screens protect the front and the back of the microphone from dirt and mechanical injury. Organdy and fiber glass inside the front and back of the microphone are used to damp the lightweight aluminum foil ribbon. The motor assembly uses Alnico magnets shaped to reduce magnetic leakage to a minimum, and increase the air gap flux density. This magnetic leakage is further reduced by means of a yoke or keeper.

A swivel arrangement permits tilting the microphone back approximately 85°. Pleasing functional design incorporating excellent performance and rugged construction, attractively finished in TV gray and satin chrome, makes this microphone a welcome addition to any installation. A two conductor shielded cable permanently attached to the microphone is connected for low impedance operation as stocked.

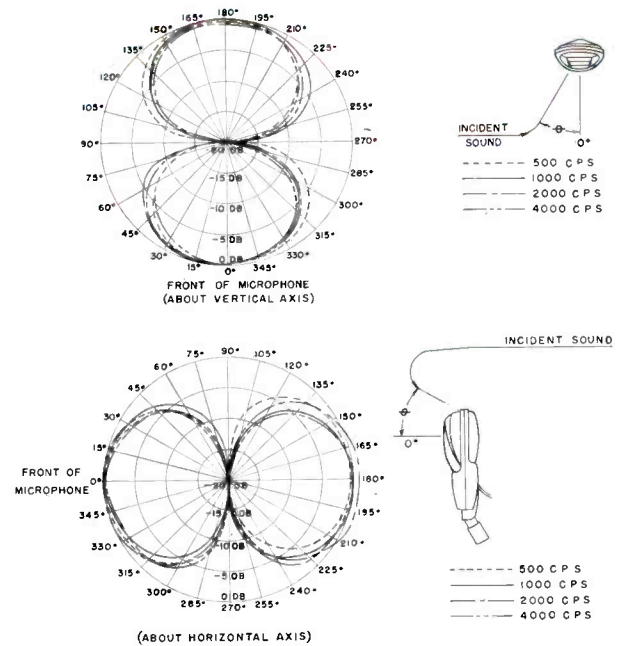

Directional Characteristics of the SK-35 and SK-46 Velocity Microphones.

**SPECIFICATIONS**

Directional Characteristics .....	Bi-directional
Output Impedance.....	200 ohms and 15,000 ohms*
Effective Output Level at 1000 cycles/second:	
Low Impedance .....	-58 dbm
$G_M$ .....	-150 db
High Impedance.....	-60 db below 1 volt
Hum Pickup Level:†	
Low Impedance .....	-113 dbm
High Impedance .....	-94 db below 1 volt
Frequency Range.....	See charts
Output Voltage:	
Low Impedance .....	117 $\mu\text{v}/\text{dyne}/\text{cm}^2$
High Impedance .....	1020 $\mu\text{v}/\text{dyne}/\text{cm}^2$
Mounting .....	$\frac{5}{8}$ -27 fixture thread
Swivel.....	Approx. 85° backward
Cable.....	Two conductor, shielded
Dimensions:	
Height .....	$5\frac{1}{8}$ "
Width .....	1 $\frac{29}{32}$ "
Depth .....	$1\frac{3}{8}$ "
Finish.....	TV gray with satin chromium plated screen
Weight (less cable).....	13 ounces
Stock Identification:	
Type SK-35 Anti-Noise Velocity Microphone.....	MI-12035
Type SK-46 Program Velocity Microphone.....	MI-12046

\* Stock with soldered connection to the 200 ohm tap.  
 † Relative to field of  $1 \times 10^{-3}$  gauss.

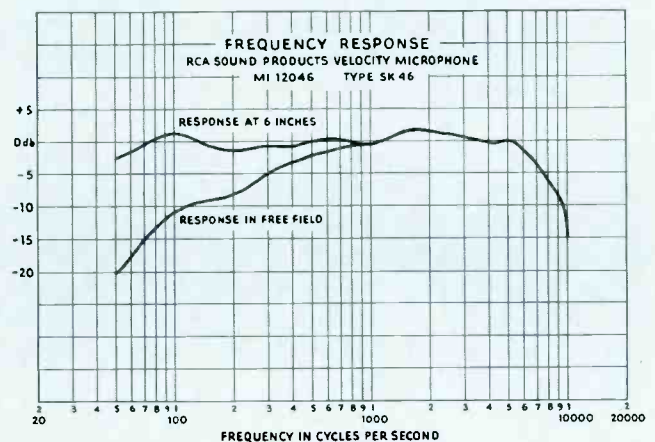
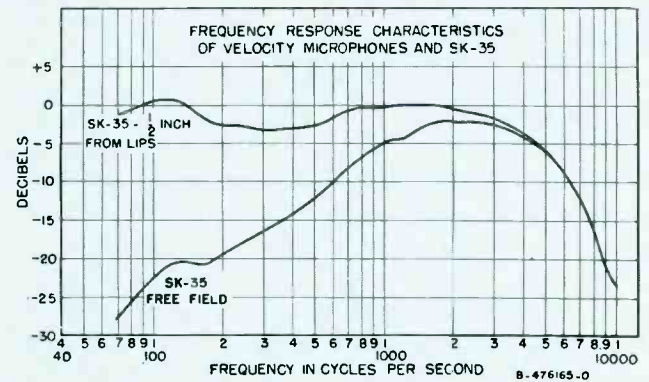

# MICROPHONE DESK STANDS



MI-6427



MI-4096-A



MI-12066-B



MI-13240-A



MI-11008



MI-4002-E

## FEATURES

- **A variety of Announce Stands to accommodate a variety of microphones**
- **Rugged construction**
- **Attractive appearance**
- **Easy to assemble or take apart**
- **Optimum design features built into each stand for its particular application**
- **Compact and convenient for portability**

## USES

RCA offers to broadcasters a complete line of microphone desk stands in a variety of types and models for every application—station, auditorium, banquet hall, or stage. All are sturdily constructed and accommodate a variety of microphones. Each offers optimum design features to assure best results for its particular application.

In addition to various types of microphone stands, RCA also offers a wide variety in styling and price range to meet individual needs. The styling is modern and attractive, employing attractive metallic finishes for radio and entertainment applications, but using dull finishes designed to blend into the background in models which will find their chief use before the TV camera. A smartly designed table pushmike stand, MI-2647, is available for applications where it is necessary to turn the microphone on and off at the microphone position. Flexible microphone stands are a convenient type mounting where the operator needs the microphone as a permanent part of an installation yet wishes to push the microphone out of the way at times.



## DESK STAND, TYPE 91-C

### FEATURES

- Small size
- Heavy base with felt covered bottom
- Adjustable height
- Attractive appearance

### USES

The 91-C is a heavy-based desk stand designed especially for studio or announce use. It is attractive in appearance and easily mounts the heaviest of studio microphones. It can accommodate Type 77-DX, BK-1A and BK-5A Microphones.

### DESCRIPTION

The 91-C is finished in umber gray with satin chrome trim. The base is felt covered to prevent marring the surface on which it is placed. The stand is provided with alternate mounting extensions—one 3/4" and one 1 3/4", the choice depending on the type microphone to be mounted.



### SPECIFICATIONS

Microphone Mounting.....	1/2" pipe thread
Base Dimensions.....	4 1/2" x 6 5/8" x 3/4"
Finish.....	Umer gray wrinkle with satin chromium trim
Weight .....	4 lbs.
Stock Identification .....	MI-4092-E



## ANNOUNCE STAND, MI-4096-A

This attractively-designed announce stand is adjustable from 8 to 10 1/2", making it ideal for use on a desk or table. It is finished in chromium and black and features a 7 1/2" base. The microphone mounting is a 5/8"—27 fixture thread. This stand can accommodate SK Series and BK-1A Microphones.

Weight (unpacked).....	4 lbs.
Stock Identification .....	MI-4096-A

## DESK STAND, MI-13240-A

This sturdily constructed desk stand is ideal for use with the lighter microphones where a low cost stand is needed. The stand is 6" high and the 4 3/4"-diameter base is equipped with a rubber cushion. The stand is attractively finished in umber gray with polished chrome trim. As supplied the stand mounting is 1/8" pipe thread; with the adaptor removed the mounting is a 5/8"—27 fixture thread. For use with Type SK-35, SK-45 and SK-46 Microphones.

Weight (unpacked).....	14 ozs.
Weight (packed).....	1 1/2 lbs.
Stock Identification .....	MI-13240-A





## PUSHMIKE STAND, MI-6427

This smartly designed table stand features a built-in microphone switch and is suitable for use with SK-Type and BK-1A Microphones. The switch is of the D.P.D.T. long leaf anti-capacity type and permits turning the microphone on and off right at the microphone stand. It may also be used for "push-to-talk" operation or lock-in "Talk" position.

The stand is 4 $\frac{3}{4}$ " high with 5 $\frac{3}{4}$ " base and is attractively finished in chromium. The microphone mounting is for a  $\frac{5}{8}$ "—27 male or female thread. Stock MI-12055 Adaptor is available on separate order for microphone with  $\frac{1}{2}$ " pipe thread.

Weight (unpacked) .....1 $\frac{1}{8}$  lbs.  
 Stock Identification .....MI-6427  
 (Includes MI-6425 Pushmike Adaptor and MI-6426 Base)

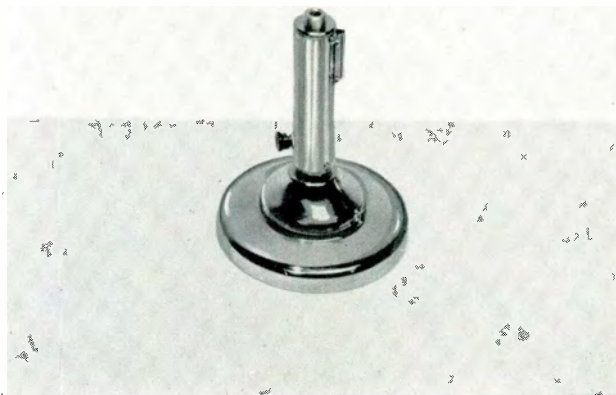

## DESK STAND, Type KS-11A

RCA's KS-11A desk stand was specifically designed for use with the type BK-1A "Commentator" Microphone. Its construction is simple, rugged and it is styled in dark umber gray finish. The BK-1A Microphone fits into the center hole and is secured by a knurled thumb screw and a retaining washer. A rubber cushion around its perimeter prevents marring of any surface.

Weight, packed.....1 $\frac{1}{2}$  lbs.  
 Finish.....Dark umber gray  
 Stock Identification .....MI-11008



## DESK STAND, Type KS-5A

This attractive base is designed primarily for use with the SK-Type microphones. It is of die cast metal 4 $\frac{1}{8}$ " long, 5 $\frac{3}{8}$ " wide and 1" high and is attractively finished in dark umber gray metalustre. The microphone is held rigidly in position by  $\frac{5}{8}$ "—27 thread bolt. The bottom is rubber cushioned giving adequate protection to any finely finished surface.

Weight (unpacked).....1 $\frac{1}{4}$  lbs.  
 Stock Identification .....MI-12066-B

The Type SK-5A Desk Stand provides an ideal mounting for the SK-46 Program Microphone shown here. Ruggedly built, and compact, it can not tip over.



## FEATURES

- Quick clamp-positioning of microphones anywhere
- Goose neck swivel adjustable for individual use
- Attached or removed with one thumb screw
- Sturdy construction, strong tubing and castings
- Attaches easily to RCA announce microphones



## USES

The MI-11745 and MI-11746 Flexible Microphone Stands are especially useful in locations where the microphone must be a permanent part of an installation yet must be adaptable to varying uses and be able to be pushed out of the way if necessary. These stands are particularly suitable for the BK-1A "Commentator" pressure microphone, but may be used with any of the smaller announce microphones such as the SK-35, SK-45 and SK-46.

Mounting Bracket, MI-11747, is designed for use with the flexible stands and may be easily clamped to the side of a console, desk, or other solid flat surface.

## DESCRIPTION

The Flexible Microphone Stands consist of a flexible goose neck either 13" long (MI-11745) or 19" long (MI-11746) which is adjustable for individual use; and a bracket clamp (MI-11747) which has a 6" chrome stem and gray crackle-finish clamp. The goose neck stands have a 5/8"-27 thread male fitting on one end and a 5/8"-27 thread female fitting on the other. They can be fitted directly to the SK-35 Type Microphones and the bracket clamp stem. For use with the BK-1A Microphone an MI-12055 Microphone Adaptor is required.

## SPECIFICATIONS

### STANDS

Finish .....	Polished chrome
Mounting .....	5/8" 27-thread (male fitting on one end, female on other)
Weight:	
MI-11745 .....	1 lb.
MI-11746 .....	1 1/2 lbs.
Length:	
MI-11745 .....	13"
MI-11746 .....	19"

### BRACKET CLAMP

Finish:	
Base .....	Gray wrinkle
6" Stem .....	Polished chrome
Mounting:	
Base .....	5/8" 27-thread female
Stem .....	5/8" 27-thread male
Weight (Base and Stem) .....	11 lbs.

### Stock Identification

13" Flexible Stand .....	MI-11745
19" Flexible Stand .....	MI-11746
Flexible Stand Bracket Clamp .....	MI-11747

### Accessories

Adaptor, 5/8"-27 Stand to 1/2" Mike .....	MI-12055
---	----------

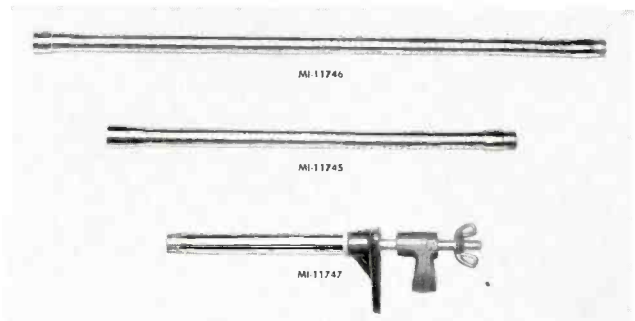

# MICROPHONE FLOOR STANDS

TYPE 90-A, MI-4068-D, MI-6208, MI-4093-C

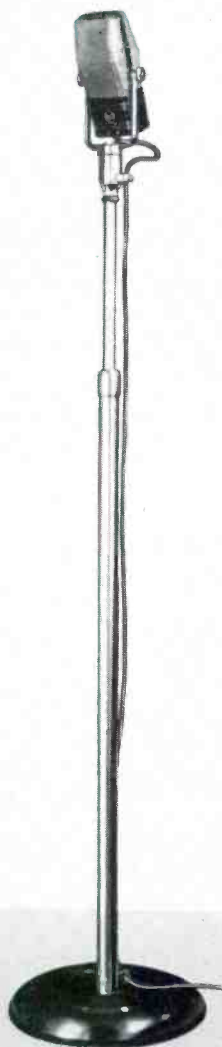

## FEATURES

- Hundreds giving excellent performance in leading broadcast studios
- Suitable for use with all RCA Microphones
- Large heavy base with equalizing projections assure sturdy support of microphone
- Simple non-slide, trouble-free clamping device
- Attractively finished in satin chrome

## USES

The Type 90-A Program Stand is used in broadcast studios where a stand is required which will be attractive in appearance and give stable support even to the heavier type of microphones. It is recommended for use with Microphone Types 77-DX, BK-1A, and BK-5A.

## DESCRIPTION

The 90-A Floor Stand is a sturdily constructed stand which will give stability to the heaviest microphones. The base is weighted and has equalizing projections which assure a firm position on an uneven floor. The column is equipped with a simple clamping device which permits height adjustments to be made easily and quietly without operating any release mechanism. The up and down operation is smooth and the locking operation positive. The patented clamp is mechanically simple and is ruggedly constructed to give years of service.

The stand as supplied may be used with any microphone having a  $\frac{1}{2}$ " pipe thread and by simply removing an adaptor fitting with any microphone having a  $\frac{5}{8}$ "—27 fixture thread.

The 90-A is finished in satin chrome to harmonize with RCA microphones. Cable guides are included to hold the microphone cord close to the stand at the base. Cable Hook, MI-11099-A is offered as an accessory item to further secure loose cables and hold them in place.

## SPECIFICATIONS

Height of Stand.....	Adjustable from 3'8" to 6'2"
Microphone Mounting.....	Standard $\frac{1}{2}$ " pipe thread or $\frac{5}{8}$ "—27 fixture thread
Diameter of Base.....	12 $\frac{1}{4}$ "
Weight (unpacked).....	33 lbs.
Finish .....	Satin Chrome
Stock Identification Type 90-A.....	MI-4090-A
Accessory Item—Cable Hook.....	MI-11099-A





MI-4068-D

MI-6208

## FLOOR STAND, MI-4068-D

### USES

The MI-4068-D Floor Stand is used in broadcast studios where some stability of support may be sacrificed for ease in moving from one spot to another. It may be used with the BK-1A, BK-5A, 77-DX and SK Series Microphones.

### DESCRIPTION

The column and telescoping tube are finished in polished chrome and the base in dark umber gray wrinkle to harmonize with RCA microphones. It has a smooth-operating clamping and release device.

The stand as supplied may be used with any microphone having a 5/8"–27 fixture thread. It is equipped with a heavy 12" base and is sturdily constructed.

### SPECIFICATIONS

Height of Stand.....	Adjustable from 34" to 62"
Microphone Mounting.....	5/8"–27 fixture thread
Diameter of Lower Tube.....	1"
Diameter of Base.....	12"
Weight (unpacked).....	14 lbs.
Finish:	
Base.....	Dark umber gray
Stand.....	Satin chrome
Stock Identification.....	MI-4068-D

## SECTIONAL STAND, MI-6208

### FEATURES

- Utility stand for floor or banquet use
- Three sections for easy packaging or carrying
- Heavy ten-inch base
- Attractive appearance

### DESCRIPTION

The MI-6208 is a convenient and attractive stand for floor or banquet use. It is especially suitable for portable use since it may be taken apart into three sections for easy packing or carrying. The stand, which is in chrome, has a heavy 10" gray crackle base trimmed with satin-silver stripes. Use this stand with 77-DX, BK-1A and BK-5A Microphones.

### SPECIFICATIONS

Height (for floor use—3 sections).....	Adjustable from 3' 11" to 5'
Height (for banquet use—2 sections).....	Adjustable from 1' 6" to 2' 7"
Microphone Mounting.....	5/8"–27 fixture thread
Finish:	
Stand.....	Polished chromium
Base.....	Umber gray wrinkle with satin-silver stripes
Weight (unpacked).....	11 lbs.
Stock Identification.....	MI-6208

## PORTABLE STAND, MI-4093-C

### DESCRIPTION

The KS-2A is a folding, lightweight and rugged stand which is unexcelled for field use with the 77-DX, BK-1A and BK-5A Microphones. It features a tripod base and a patented clutch arrangement which permits height adjustments to be quickly made without the operation of a mechanical release.



### SPECIFICATIONS

Height.....	Adjustable from 3' to 5'
Weight (unpacked).....	3 1/2 lbs.
Finish.....	Satin chrome
Microphone Mounting.....	1/2" pipe thread or 5/8"–27 fixture thread with adaptor removed
Stock Identification.....	MI-4093-C

# MICROPHONE BOOM AND STAND

## TYPE KS-3B



The Type KS-3B Boom Stand may be conveniently folded for storage or transportation as shown in inset.

### USES

The RCA Type KS-3B Microphone Boom and Stand affords proper microphone placement for: programs where the best microphone position cannot be reached with a conventional floor stand; piano pickup; orchestral pickup where the stand may be substituted for microphones suspended overhead; television programs where movement of the microphone is not required. This stand is recommended for use with the 77-DX and BK-5A Microphones.

### DESCRIPTION

The KS-3B boom length and the counter balance overhang are easily adjustable, and the position selected is securely locked by wing-type handwheels. The microphone fitting is swivel mounted, thus eliminating the need of rotating the microphone when attaching it to the stand. Movement of the stand is quiet and easy because of the smooth-rolling

### FEATURES

- Sturdy construction, strong tubing and castings
- Large base with rubber-tired casters
- Easily adjusted over wide range of heights and boom lengths
- Positive locking adjustments
- Air cushion lowering brake, releases for easy lift
- Lightweight

rubber-tired casters with which it is equipped. Once the stand is properly placed the casters can be locked by means of foot-operated locks. Cable supports are provided along the boom for the microphone cable.

For storage or for convenient transport the legs and the boom may be folded against the center column to make a relatively small package.

The KS-3B Boom Stand is finished in satin chrome and gray to harmonize with RCA microphones.

### SPECIFICATIONS

Height of Stand.....	Adjustable from 5' 2" to 8' 8"
Horizontal Arm Adjustment (with overhang to rear).....	3' to 6'
Microphone Mounting.....	Standard 1/2" pipe thread
	5/8"—27 fixture thread with adaptor removed
Weight (unpacked).....	64 lbs.
Finish.....	Satin stainless steel and gray
Stock Identification.....	MI-11056

# MICROPHONE BOOM AND STAND

MI-11070

## FEATURES

- Suitable for both TV and AM—rotates "Mike" through 360° by convenient wheel
- Permits the operator to "spot" directional pattern of mike for best pickup
- Three sturdy telescopic aluminum sections provide "length" adjustments from 6 to 18 feet
- A shockproof rubber mount for microphone
- Mike cable enclosed in boom
- Vertical adjustment 4 to 8 feet
- Base mounted on rubber-tired casters



## USES

For broadcast AM and FM studio and Television applications the RCA MI-11070 Microphone Boom and Stand is used for: programs where the best microphone position cannot be reached with a conventional floor stand; piano pickup; orchestral pickup where the stand may be substituted for microphones suspended overhead; television programs of virtually all types. It is recommended for use with Type 77-DX and BK-5A Microphones.

## DESCRIPTION

The Microphone Boom Stand, MI-11070, telescopes from 6' 10" to 18' with remote control of microphone made possible at all positions by a rear handwheel which rotates 360 degrees. It is equipped with a self leveling, vibration damping mount. The microphone cable runs through the boom to avoid "snarls" and interference with the television scenes.

Perfect balance is maintained by an adjustable, 25 pound steel counterweight which slides on the boom and locks securely at any position. The counterweight is made of steel, plated satin chrome and the boom swivel is cast

aluminum with a bronze stand swivel. The stand swivel has a tension spring to keep the boom in position when balanced. The stand is a two-section telescoping super strut which combines rigidity and strength with minimum weight.

The vertical portion of the stand is constructed of telescopic steel tubing, and is adjustable in height from 4 feet to 8 feet. A Numo check and safety clamp are provided for the height adjustment. A spring shock absorber on the inner telescopic tube protects against shock if the height adjustment is carelessly loosened. The base is mounted on 4-inch rubber tired casters, and may be folded compactly for convenience in transportation or storage. A horizontal handle is provided at the top of the vertical section for convenience in dollying the stand.

## SPECIFICATIONS

Height of Stand.....	Adjustable from 4' to 8'
Horizontal Arm Adjustment.....	Telescopes 6' 10" to 18'
Microphone Mounting.....	Shockproof rubber mount with 1/2" pipe thread
Microphone Adjustment.....	Rear handwheel
Weight (approx.).....	70 lbs.
Finish.....	Satin, stainless steel and gray
Stock Identification .....	MI-11070



# MICROPHONE BOOM AND PERAMBULATOR

MI-26574

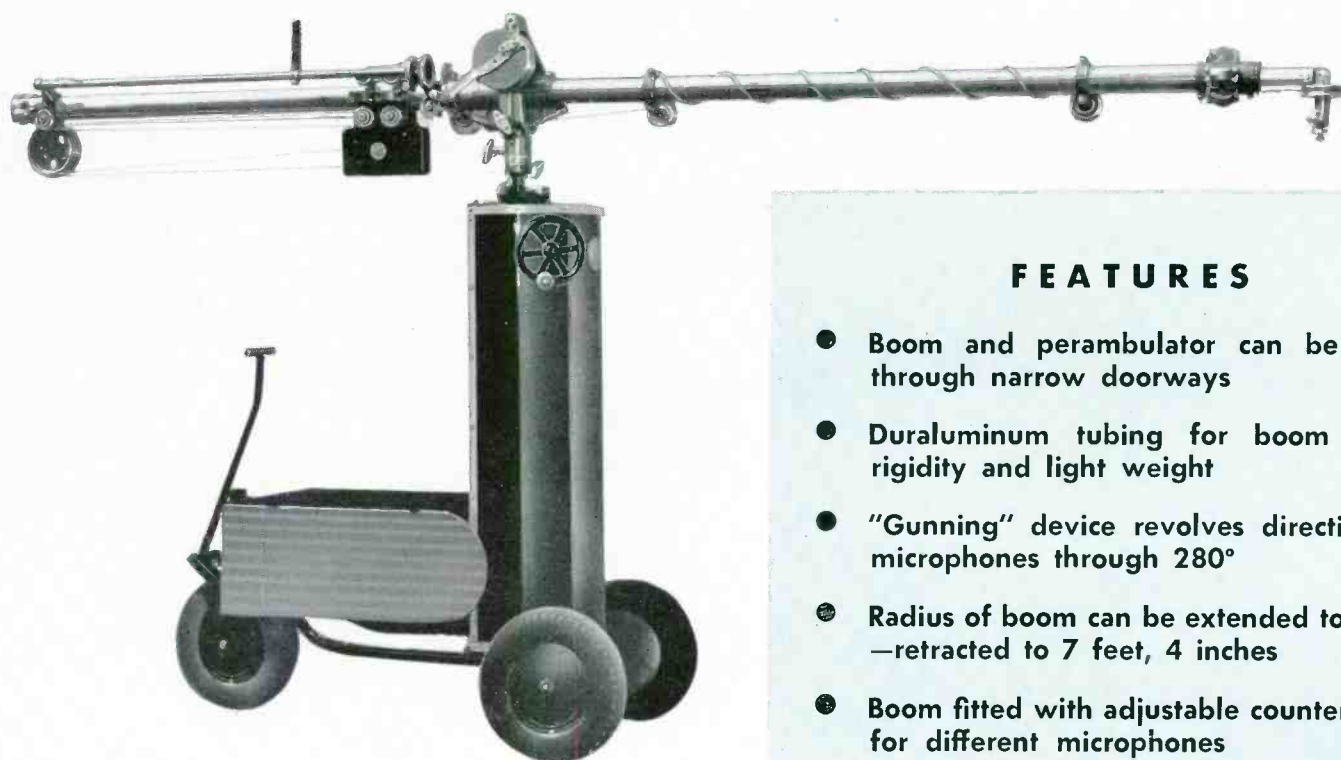

## FEATURES

- Boom and perambulator can be passed through narrow doorways
- Duraluminum tubing for boom assures rigidity and light weight
- "Gunning" device revolves directional microphones through 280°
- Radius of boom can be extended to 17 feet —retracted to 7 feet, 4 inches
- Boom fitted with adjustable counterbalance for different microphones
- Quiet in operation

## USES

The MI-26574 Microphone Boom and Perambulator is designed for use in broadcast or television studios. It enables the operator to quickly place the microphone with respect to the sound source. He can closely follow the sound, or move from one source of sound to another easily and quietly. The boom accommodates such microphones as RCA Types 77-DX and BK-5A Microphones.

## DESCRIPTION

The perambulator is constructed of steel tubing with drop-rim type wheels and pneumatic tires. The steering wheel swivels 180° and can be clamped to hold a given radius. The tiller when pushed back operates a toggle brake on the steering wheel. It is also provided with steps which aid the operator in mounting the platform when it is elevated. Operated by a hand wheel, the elevating column raises the boom from a height of 6 feet, 5 inches to 9 feet, 5 inches. The operating platform raises with the boom. The wheel tread of the perambulator can be narrowed to 27 inches and the leaf portions of the table can be lowered to permit passing the perambulator through a 30-inch door.

A hand crank governs extension and retraction of the boom, and a hand rail controls elevation and horizontal traversal. As the boom is retracted, the microphone cable is received on take-up sheaves. The movement of the telescoping member is counterbalanced by weights which can be adjusted to properly balance different microphones. Since many microphones are directional, the boom is fitted with a "microphone gunning" device which revolves the microphone through 280°.

## SPECIFICATIONS

Dimensions:	
Maximum Height (with boom pedestal elevated).....	9' 5"
Maximum Height (with pedestal lowered).....	6' 5"
Length of Boom:	
Extended .....	17'
Retracted .....	7' 4½"
Weight:	
Boom (with gunning device and counterweights).....	102 lbs.
Perambulator .....	421 lbs.
Stock Identification .....	
Boom Only .....	MI-26574-1
Perambulator Only .....	MI-26574-2

# MICROPHONE ACCESSORIES

## Type "XLR"

Microphone Receptacle (Male)  
MI-11087-B



Microphone Plug (Female)  
MI-11090-A



Microphone Receptacle (Female)  
MI-11088-B



Microphone Plug (Male)  
MI-11089-A

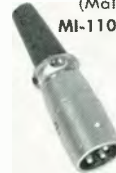

## Type "XL"

Receptacle  
MI-11069



## Type "UA"



Microphone Plug  
MI-11062



Receptacle,  
MI-11063



Cord Connector  
MI-11061



Wall Receptacle  
MI-4624-A

## Type "P"



Microphone Plug  
MI-4630-B



Cord Connector  
MI-4620-B

## MICROPHONE PLUGS AND RECEPTACLES

RCA microphones are sold without plugs in order that the purchaser may use any type desired. Three series of Cannon plugs which meet requirements for reliability and ruggedness are stocked. These include the "UA" Ultimate series of plugs which have been designed as a result of RETMA recommendations, the "P" Type Connectors and the "XLR" and "XL" matched family of small 3-contact connectors.

The "UA" connectors are splash-proof and shock-proof, and have gold-plated contacts for low-loss and noise-free operation. Flat top construction provides positive polarization. All have thumb action latch-lock for quick insertion and firm engagement and a 1 3/4" rubber sleeve handle for firm easy grip.

The "P" connectors are desirable as panel receptacles and cable connectors for audio circuits. They accommodate wires up to No. 10, 15 ampere contact capacity and feature black phenolic insulation. The Cannon "XL" and "XLR"

type plugs and receptacles are miniature connectors especially favored with newer type miniature microphones and equipment. They have similar functions to the "P" type units.

Description	Cannon Stock No.	RCA Stock Identification
Female Plug for Microphone Extension Cable (mates with UA-3-12).....	UA-3-11	MI-11061
Male Plug for Microphone Cable (mates with UA-3-11 and UA-3-13)....	UA-3-12	MI-11062
Flush Mounting Receptacle (mates with UA-3-12) .....	UA-3-13	MI-11063
Male Plug for Microphone Cords.....	P3-CG-12S	MI-4630-B
Wall Receptacle for Above Plug.....	P3-35	MI-4624-A
Note: The MI-4624-A Receptacle will fit in a standard a-c outlet box.		
Extension Cord—Female Connector.....	P3-CG-11S	MI-4620-B
Male Connector for BK-4A.....		MI-11069
Microphone Receptacle, Female.....	XLR-3-31	MI-11088-B
Microphone Receptacle, Male.....	XLR-3-32	MI-11087-B
Microphone Plug, Female.....	XLR-3-11C	MI-11090-A
Microphone Plug, Male.....	XLR-3-12C	MI-11089-A





## MICROPHONE ADAPTORS

Here is a comprehensive stock of microphone adaptors suitable for microphones and stands used by broadcasters. The 1/2" standard pipe thread avails broadcasters of adaptors to suit any application.

Stand Thread	Microphone Thread	Stock Identification
1/2" pipe thread	1/8" pipe thread	MI-12051
1/2" pipe thread	5/8"-27	MI-12053
1/2" pipe thread	5/8"-24 (W.E.)	MI-11066-2
5/8"-24 (W.E.)	1/2" pipe thread	MI-11066-3
5/8"-27	1/8" pipe thread	MI-6229
5/8"-27	1/2" pipe thread	MI-12055
5/8"-27	1/2" pipe thread	MI-11009

## MICROPHONE CABLES

RCA microphone cables are of rugged construction and are jacketed with a neoprene compound to insure long life. They are especially designed for broadcast service either studio or remote.

### Cable MI-43-C

Use.....Cable for low impedance microphone circuits  
 Type.....Three conductor, twisted  
 Conductors.....Tinned cadmium bronze, stranded, equivalent to #20 AWG  
 Insulation.....Special rubber compound  
 Shield.....Tinned copper. Complete coverage without loss in flexibility  
 Outer covering.....Brown neoprene compound  
 Overall Diameter.....0.300 maximum  
 Stock Identification (specify length in feet).....MI-43-C

### Cable MI-13307

Type.....Two conductor, twisted  
 Conductors.....Stranded, equivalent to #16 AWG  
 Insulation.....Special rubber compound  
 Shield.....Tinned copper. Complete coverage without loss in flexibility  
 Outer Covering.....Black neoprene compound  
 Overall Diameter.....0.300 maximum  
 Stock Identification (specify length in feet).....MI-13307

### Cable MI-13322

Type.....Two conductor, twisted  
 Conductors.....Stranded cadmium bronze, equivalent to #24 AWG  
 Insulation.....Special rubber compound  
 Shield.....Conducting cotton with 60% coverage of tinned copper. (Complete coverage with greater flexibility)  
 Outer Covering.....Brown neoprene compound  
 Overall Diameter.....0.215 maximum  
 Stock Identification .....MI-13322



## INTERCONNECTING CABLES

The majority of cables required to interconnect the various components of a broadcast audio assembly are of a special type and cannot be readily purchased from the local

electrical dealer. In order to avoid unnecessary installation delays, RCA carries in stock four of the generally used special type cables.

### Solid Conductor Cable, MI-33

Use.....General purpose Audio Transmission Line  
 Type.....Shielded twisted pair, each conductor solid #20 tinned copper wire, with Vinyl resin insulation covered with lacquered rayon braid.  
 Shield.....Tinned copper braid  
 Overall Diameter .....Approximately .170"  
 Color Code.....Red and black  
 Rating .....300 volts  
 Stock Identification (stocked in 1000 ft. rolls).....MI-33

### Stranded Conductor Cable, MI-35

Use.....Especially recommended for 110 volt supply and filament circuits  
 Type.....Shielded, twisted pair, stranded, composed of 16—.010 tinned copper conductors equivalent to #18 AWG  
 Insulation.....Vinyl resin insulated with lacquered rayon braid  
 Shield.....Tinned copper braid  
 Overall Diameter .....Approximately .236"  
 Color Code.....Red and black  
 Rating .....300 volts  
 Stock Identification (stocked in 1000 ft. rolls).....MI-35

### Stranded Conductor Cable, MI-34

Use.....Recommended for audio circuits where extra flexibility is required  
 Type.....Shielded, twisted pair, stranded, composed of 7—.010 tinned copper conductors equivalent to #22 AWG  
 Insulation.....Vinyl resin insulated with lacquered rayon braid  
 Shield.....Tinned copper braid  
 Overall Diameter .....Approximately .166"  
 Color Code.....Red and black  
 Rating .....300 volts  
 Stock Identification (stocked in 1000 ft. rolls).....MI-34

### Stranded Conductor Cable, MI-13306

Use.....General purpose Audio Transmission Line  
 Type.....Black Glazed Cotton covered shielded twisted pair, each conductor #22 AWG Stranded 71010, with Vinyl resin insulation covered with lacquered rayon braid.  
 Shield.....Tinned copper braid  
 Overall Diameter .....Approximately .200"  
 Color Code.....Red and black  
 Rating .....300 volts  
 Stock Identification (stocked in 1000 ft. rolls).....MI-13306

## CABLE HOOK, MI-11099-A

### USES

Can be quickly attached to or removed from the 90-A or any other 1 1/4" round tube stand. It provides a convenient method of holding the cable. It saves wear on the cable when it is not in use.

### DESCRIPTION

The Cable Hook is simple to install, and may be easily adjusted to the proper height. Merely tightening a smooth locking nut holds it in position.

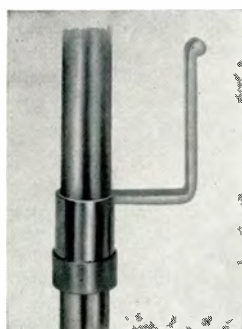

### SPECIFICATIONS

Weight .....15 oz.  
 Finish .....Satin chrome  
 Hole Diameter .....1 1/4"  
 Stock Identification .....MI-11099-A

## CABLE LACING CORD



Lacing cord is available for general cable lacing and dressing uses. Cord is of strong material such as linen and hemp and thoroughly impregnated with a beeswax and paraffin mixture. Supplied in one pound spools as shown above.

Stock Identification	Type	Plys	Yds/lb	Average Break Strength
MI-11719-A	No. 6 med.	4	580 ±35	30 lbs.

# STANDARD CONSOLETTA

## TYPE BC-3B

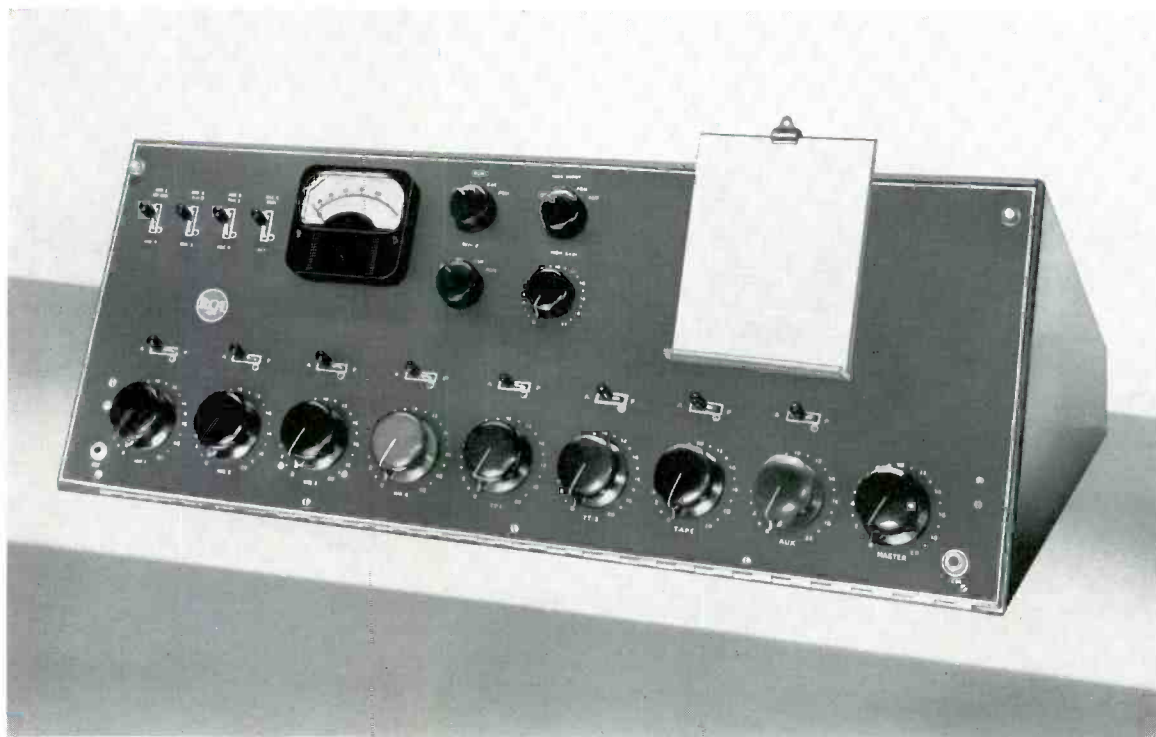

### FEATURES

- Complete high-fidelity speech input system
- Provides facilities for thirteen inputs
- Modular construction, etched wiring sub-assemblies
- Compact size—entirely self contained (includes all amplifiers and power supply)
- Means for supporting script on front panel
- Styling matches other RCA audio consoles and is compatible with TV terminal equipment
- Maximum facility at new standard of economy

### USES

The new RCA Type BC-3B Standard Console provides audio amplification, switching, control and monitoring facilities essential to the operation of medium size radio or television broadcast stations. This model incorporates eight mixer positions, which control the thirteen inputs. It

provides sufficient flexibility to accommodate two studios, announce booth, control room, transcription turntables and auxiliary input circuitry.

The BC-3B Console may be matched with a BC-5A audio console to provide true dual channel master control operation. The styling of the BC-3B is uniform with all other RCA audio consoles. The unit provides maximum facilities at new low cost. It is also economical to operate, and has been designed for operating convenience and ease of servicing.

### DESCRIPTION

The new Standard Console, Type BC-3B, is a compact, self-contained audio speech input system mounted in a smartly styled housing of all-metal construction and finished in two-tone umber gray. A hinged front panel and removable cover provide access to tubes, switches, gain controls and other interior components.

An etched panel contains all operating controls, an illuminated volume indicator calibrated in VU's, and a rack designed to hold script. Extremely flexible in operation, the BC-3B will handle thirteen separate inputs with provisions for simultaneous mixing of any eight inputs. There

is provision for feeding program cue or talkback to remote lines. Headset jacks are provided for network and remote line monitoring. Cue positions are incorporated on turntable mixers. Separate audition and program channels are provided for maximum flexibility and the monitoring amplifier may be switched from the turntable cue position, program line or audition bus. All inputs are terminated when the switches are in the off position.

The BC-3B is of modular construction with etched wiring sub-assemblies. It has self-contained amplifiers and power supply. Three preamplifiers are utilized in the design plus monitoring and booster equipment. Recommended operating practice is for the inclusion of separate BA-12A preamplifiers mounted in each turntable cabinet. The unit control circuits include two 24 volt relays for control room and studio speaker and On Air light operation controlled by microphone selector and program-audition switches.

**SPECIFICATIONS**

**Inputs:**

6 Microphones (4 Studio, 1 Control Room and 1 Announce Booth)	37.5/150/600 ohms
2 Turntable Inputs	37.5/150/600 ohms
2 Remote Lines	600 ohms
1 Network	600 ohms
1 Tape	150 ohms
1 Auxiliary	150 ohms

**Outputs:**

1 Program Line	600 ohms	+18 dbm
2 Monitor Speakers	16 ohms	3 W each
1 External Monitor	600 ohms	-8 dbm
2 Remote Lines Cue	600 ohms	+18 dbm
1 Turntable Cue	50,000 ohms	1 V rms

**Gain:**

Microphone or Turntable Input to Program Line	108 db
Microphone or Turntable Input to Speaker (Audition)	125 db

**Frequency Response:**

Program ±1.5 db	30-15,000 cps
Monitor ±2.0 db	30-15,000 cps

**Harmonic Distortion:**

Program 18 dbm Output	1% @ 30 cps; .75% @ 50 cps; 0.5% @ 100-15,000 cps
Monitor 6 W Total	1% @ 50 cps; 0.5% @ 100-15,000 cps

**Signal to Noise Ratio:**

Program Channel, Mixer and Master Gain controls set for 68 db Gain	68 db below 18 dbm output
--	---------------------------

**Tube Complement:**

2 6V6-GT, 1 6X4, 2 12AU7, 2 12AX7, 1 5R4GY, 7 12AY7, 5-MI-11299 (selected 12AY7)

Power Requirements.....100-130 volts a-c, single phase, 50/60 cycles

Power Consumption.....155 watts

Dimensions.....33" wide, 11 1/4" high, 21 1/4" deep

Weight.....88 lbs.

Finish.....Two tone umber gray

Panel.....Reverse etched aluminum with dark umber gray enamel background

Stock Identification .....MI-11641

**Accessories**

Tube Kit	MI-11486
On-Air Light Relay	MI-11702-A
On-Air Sign	MI-11706-1
BA-12A Utility Amplifier	MI-11232

Simplified block diagram of the BC-3B Standard Console.

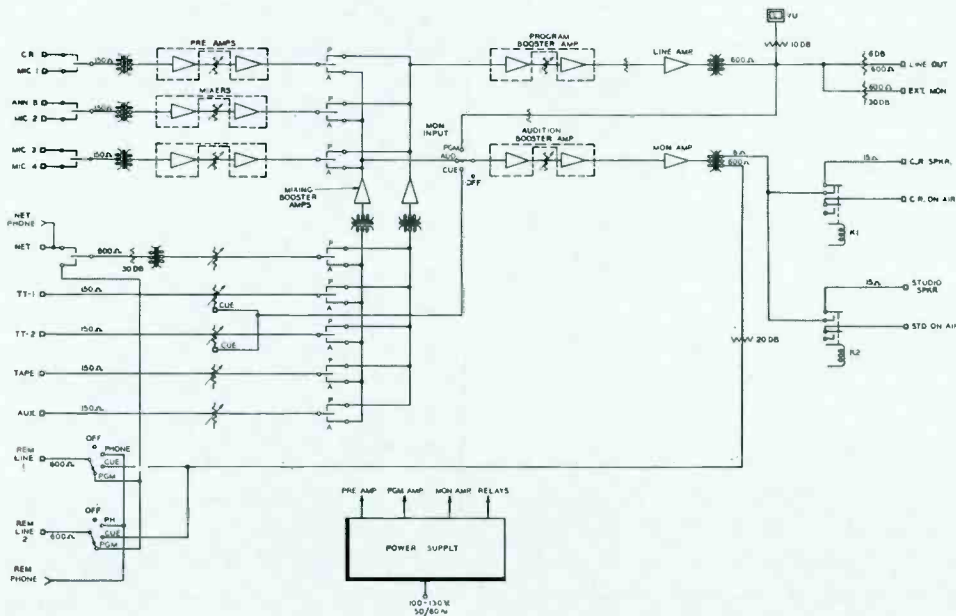



# AUDIO CONSOLETTA

## TYPE BC-5A



### FEATURES

- Easily expanded for dual-channel broadcast use
- Single BC-5A controls nine inputs—four simultaneously
- Paired BC-5A's double facilities—provide dual-channel operation
- Entirely self-contained, completely wired unit includes amplifiers and power supply
- Program and audition facilities
- Talkback or program cue to remote lines
- Four preamplifiers—all amplifiers etched wiring
- High degree of accessibility
- Modular construction

### USES

The exclusive feature of "add-a-unit" audio control incorporated in the BC-5A Consolette permits "block building" as desired, without obsolescence to existing control equipment. The unit is suitable for use either in combined studio/transmitter, or remote studio installations.

A single BC-5A provides adequate control and switching facilities for accommodating one studio, control booth, two turntables, network, remotes and tape recorder. Addition of a second BC-5A doubles facilities and permits complete dual-channel operation. It is ideally suited for such "twin" or side-by-side installations. The audio consolette may also be used by television stations to provide audio sub-control, or to permit expansion of existing facilities. Thus it is possible to combine the BC-5A equipment with the RCA type BC-3B consolette to provide dual channel operation and a total of twenty-two inputs. The equipment is styled to match all current RCA consolettes.

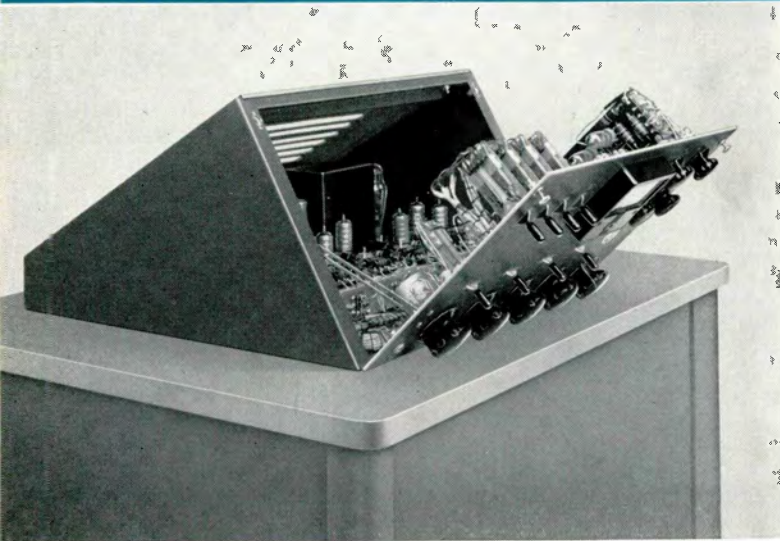

The BC-5A hinged front panel and removable top cover provide complete access to all components including amplifiers and power supply.

**DESCRIPTION**

The BC-5A Audio Consolette is a low-cost quality Broadcast Audio Control equipment. The consolette is of all-metal construction finished in two-tone umber gray. A hinged front panel and removable cover provide complete access to all components, such as the key-selector switches, controls, mixers, terminal blocks and wiring.

The VU meter and all switches and mixer controls essential to everyday programming are front-panel mounted. Extremely flexible in operation, the BC-5A handles nine separate inputs, with provisions for simultaneous mixing of four inputs. There is provision for feeding program cue or talkback to the remote lines. Headphone jacks are provided for network and remote line monitoring. The VU meter is illuminated to facilitate readings.

Cue positions are incorporated on turntable mixers, and terminals are available for connecting a separate cueing amplifier. Separate audition and program channels are provided for maximum flexibility, and the monitoring amplifier may be switched from the turntable cue position, program line, or audition bus. All inputs are terminated when the switches are in the "off" position.

The BC-5A is a completely wired unit and has self-contained amplifiers and relay power supply. Four preamplifiers are utilized in the basic design and provision is made for the addition of external line equalizers. The fourth preamplifier is supplied wired for low gain to permit its use with a remote line input. It can be easily modified, however, for high gain when desired.

**SPECIFICATIONS**

**Inputs:**

4 Microphone (3 Studio, 1 Control Room)	37.5/150/600 ohms
2 Turntable	37.5/150/600 ohms
2 Remote Lines	600 ohms
1 Network	600 ohms

**Outputs:**

1 Program Line	600 ohms	18 dbm
2 Monitor Speakers	16 ohms	3 W each
1 External Monitor	600 ohms	-12 dbm
2 Remote Lines Cue	600 ohms	18 dbm
1 Turntable Cue	50,000 ohms	1 V

**Gain:**

Microphone or Turntable Input to Program Line	108 db
Microphone or Turntable Input to Speaker	125 db

**Frequency Response:**

Program ±1.5 db	30-15,000 cps
Monitor ±2.0 db	30-15,000 cps

**Harmonic Distortion:**

Program (18 dbm output)	1% at 30 cps; 0.75% at 50 cps; 0.5% 100 to 15,000 cps
Monitor (6 W total)	1% at 50 cps; 0.5% 100 to 15,000 cps

**Signal to Noise Ratio:**

Program Channel (Mixer and Master Gain)	
Controls set for 68 db gain)	.68 db below 18 dbm output

**Tube Complement**

1—5R4GY	2—12AX7
2—12AU7	1—6X4
2—6V6-GT	6—12AY7
5—MI-11299 (selected 12AY7)	

Dimensions	19 1/2" wide, 11 1/2" high, 21 1/2" deep
Weight	66 lbs.
Finish	Two tone umber gray
Panel	Photoengraved aluminum with dark umber gray enamel fill
Stock Identification	MI-11637

**Accessories**

Tube Kit for BC-5A	MI-11483
On-Air Lights	MI-11706

Simplified block diagram of BC-5A Consolette.

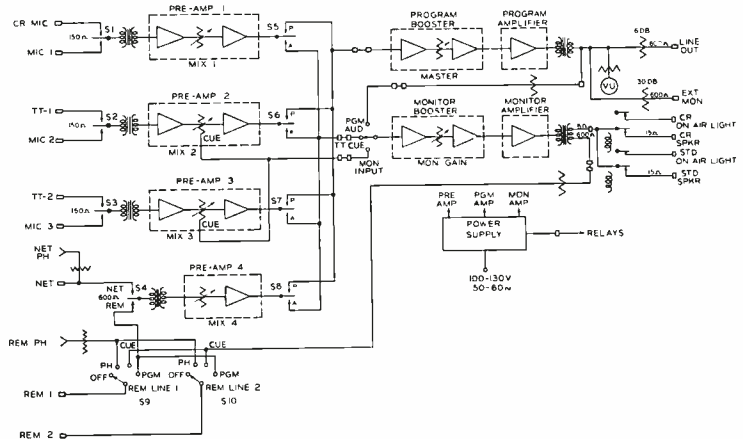

# DUAL-CHANNEL AUDIO CONSOLETTA

TYPE BC-6A



## FEATURES

- Complete high-fidelity speech input system for larger radio or TV broadcast station with nine high level mixing channels—two program channels either to feed one or both program lines
- Integrated design — modular construction; dip soldered etched wiring amplifier sub-assemblies
- Compact size—entirely self-contained (includes all amplifiers and power supplies)
- Dual monitoring channels, one for program monitoring and talkback, the other for feeding background to studios and cueing
- Incorporates new split-mixer technique
- Convenient switch for selecting two channel or single channel operation with two sub-master gain controls
- Twenty-two inputs available
- Dual power supplies—one for each channel for greater reliability
- Means for supporting script in space between VU meters
- Styling matches other audio consolettes and is compatible with TV terminal equipment





Etched front panel of the BC-6A Consolette showing entire operating facilities.

**USES**

The new RCA Type BC-6A Split-Mixer Dual Channel Audio Consolette provides the audio amplification, switching, control and monitoring facilities essential to operation of the larger radio or television broadcast station. This consolette incorporates nine mixer positions and provides all the facilities needed to accommodate one or more studios, announce booth microphone, control room microphone, two transcription turntables, tape, film, five remote lines, network and three cue circuits.

The nine mixer positions provided are assigned so as to offer the greatest flexibility and operating ease. The first five are low level microphone channels each with dual microphone input. Positions six and seven are also low level inputs and may be used for either turntable, tape or film sources; while the eighth mixer is used for network. The final mixer has provisions for five remote line inputs selected by rotary switch.

**Simplified Facilities Diagram for the new RCA Type BC-6A Split-Mixer, Dual Channel Audio Consolette.**

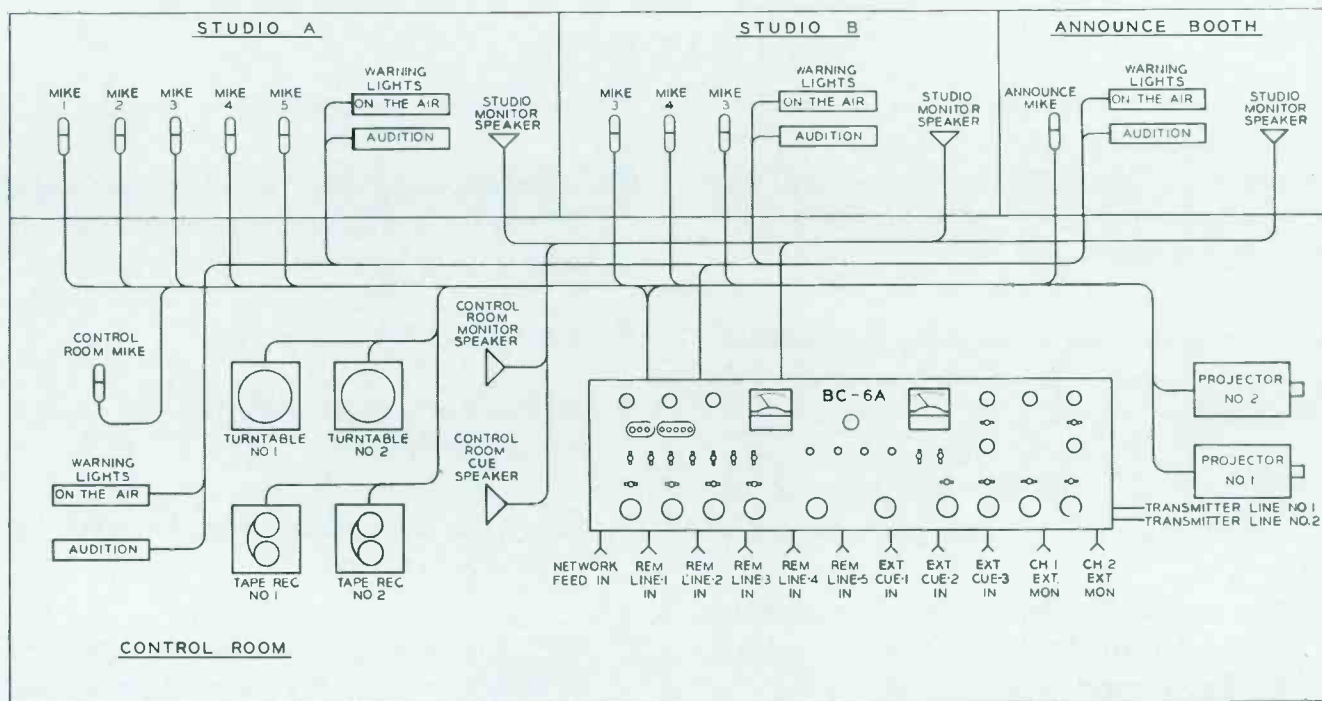

## DESCRIPTION

The BC-6A Split-Mixer Dual-Channel Audio Console is designed for operating convenience and ease of servicing—all amplifiers, control facilities and power supplies being contained in a single housing which offers utmost accessibility to all components. The unit is suitable for mounting on a flat top desk, and is similar in styling and appearance to the RCA BC-3B and BC-5A consolettes.

An etched panel contains all operating controls. It tilts forward for easy access to all contacts, switches, gain controls and other interior components. Two illuminated volume indicator meters are calibrated in VU's. They indicate level on each output channel. Monitoring and network headset jacks are supplied and headphones may be connected to the output of the program channels, remote lines, or the incoming network. Talkback facilities are included and permit talking back to studios, announce booth or remote lines. An Over-ride-Remote cue switch is provided which permits the remote operator to call in on any of the

remote lines and over-ride the program on the control room speaker.

Highest quality components are used throughout the BC-6A. Interlocked push-button switches are cam operated leaf type, assuring years of trouble-free operation. Improved fast relay circuits for speakers reduce the possibility of key clicks and audio feedback. The amplifiers are of a new, compact design of modular construction having dip-soldered etched wiring amplifier subassemblies similar to those designed for the BC-5A consolette.

The BC-6A has two power supplies, each powers a single channel and alternate pre-amplifiers thus providing greater continuity of service. Both are completely self-contained units. The total power input required is only 300 watts, 50 to 60 cps at 100 to 130 volts. The frequency response from any input to the line output is within  $\pm 1.5$  db from 30 to 15,000 cps. The total rms harmonic distortion is less than 0.5% from 100 to 15,000 cps at a line output level of 18 dbm.

Servicing new BC-6A Consolette is greatly simplified by hinged front panel and removable cover.

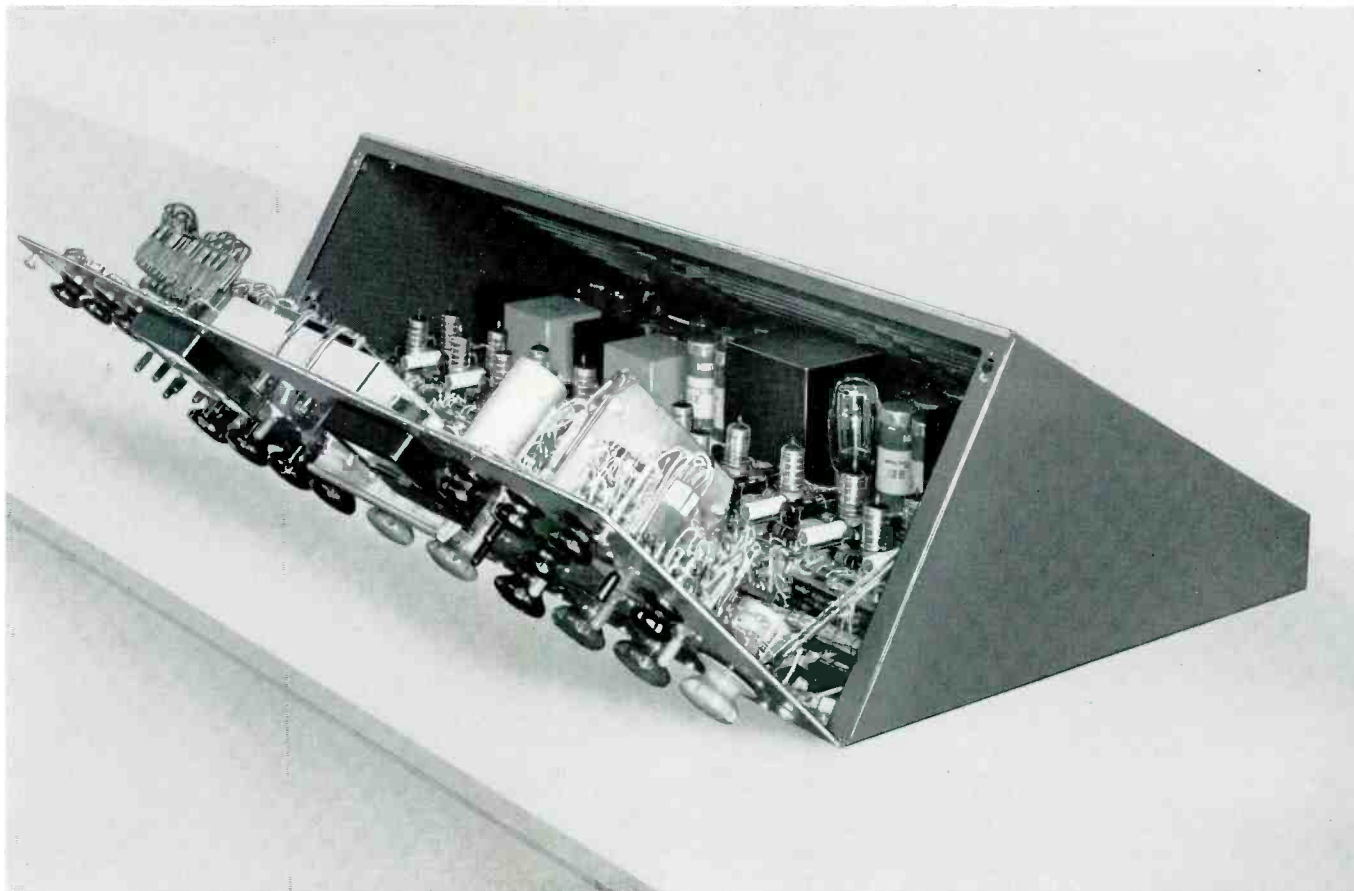

**SPECIFICATIONS**

Inputs.....10 microphones (5 used simultaneously), 2 tape, turntable or film (2 used simultaneously), 5 remote lines (1 used at a time), 1 network, and 3 cue lines.

Outputs.....2 program lines (either channel may feed either or both lines), 2 external monitors (1 for each channel), 5 speakers, 5 remote lines (remote cue).

**Source Impedance:**

Microphones.....30 or 150 ohms  
 Remote Lines and Network.....600 ohms  
 Turntables.....150 ohms  
 Monitor Cue.....20,000 ohms

**Load Impedance:**

Line.....600 ohms  
 Speaker (total of 5 speakers).....Each 15 ohms  
 Headphone Output.....600 ohms

**Output Level:**

Line (distortion less than 0.5%, 100 to 15,000 cycles).....+18 dbm after a 6 db pad  
 Speaker (distortion less than 1%, 100 to 15,000 cycles).....8 watts  
 Gain (maximum microphone to line output).....108 db  
 Frequency Response.....±1.5 db, 30 to 15,000 kc

Signal to Noise Ratio, Microphone to Program Line (68 db gain, +18 dbm output).....68 db

Power Input.....300 watts, 100/130 volts, 50/60 cycles a-c

**Tube Complement**

2-5R4-GY	4-12AX7
4-12AU7	4-6V6-GT
2-6X4	10-MI-11299 (RCA selected 12AY7)
	12-12AY7

Dimensions.....38" wide, 11½" high, 21½" deep

Weight.....127 lbs.

Finish.....Two tone umber gray

Panel.....Reversed etched aluminum with dark umber gray enamel fill

**Equipment Supplied**

BC-6A Dual-Channel Audio Console including amplifiers, power supplies and Instruction Book (IB-24788); but less tubes.....MI-11638

**Accessory**

Tube Kit for BC-6A Console.....MI-11484  
 Announce Booth Speaker Relay.....MI-11748  
 On-Air Light Relay.....MI-11702-A  
 On-Air Lights.....MI-11706

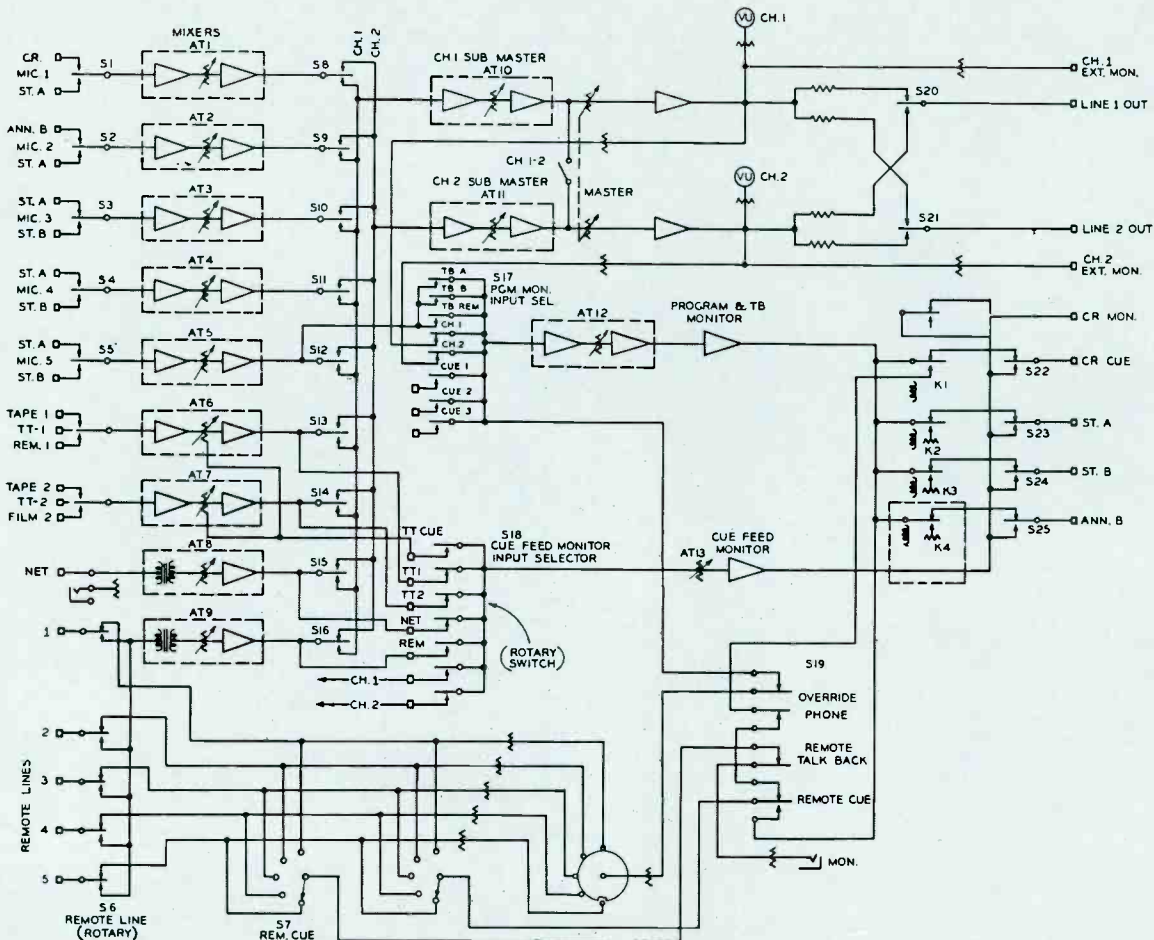

Simplified block diagram of the BC-6A Dual-Channel Audio Console.



# CUSTOM AUDIO EQUIPMENT

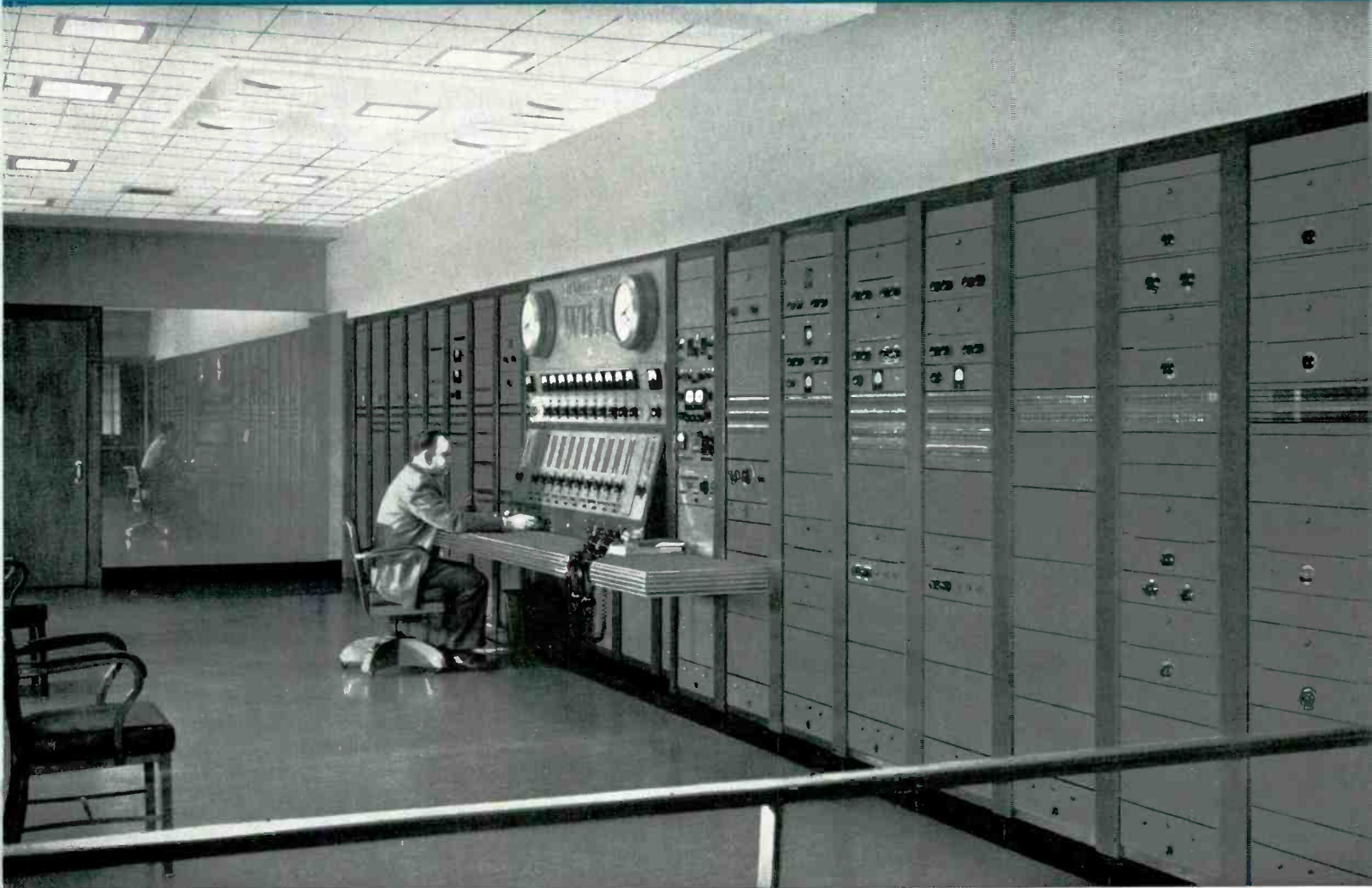

WBAP, Fort Worth. The master control installation pictured here includes 16 deluxe audio equipment racks. These are just part of WBAP's modern six-studio layout. The master control installation features an "In-Line" design for handling 16 inputs and 10 outgoing channels.

## FEATURES

- Reduced operating expense
- Increased operating efficiency
- Instant "fool-proof" switching
- "Tailor-made" to satisfy your particular programming requirements
- Smoother operation (without jumps or breaks) . . . Sounds better to listeners
- Possibilities for new business . . . More programs handled
- Increased station prestige with clients
- RCA Custom Engineering Service available to all stations, large and small

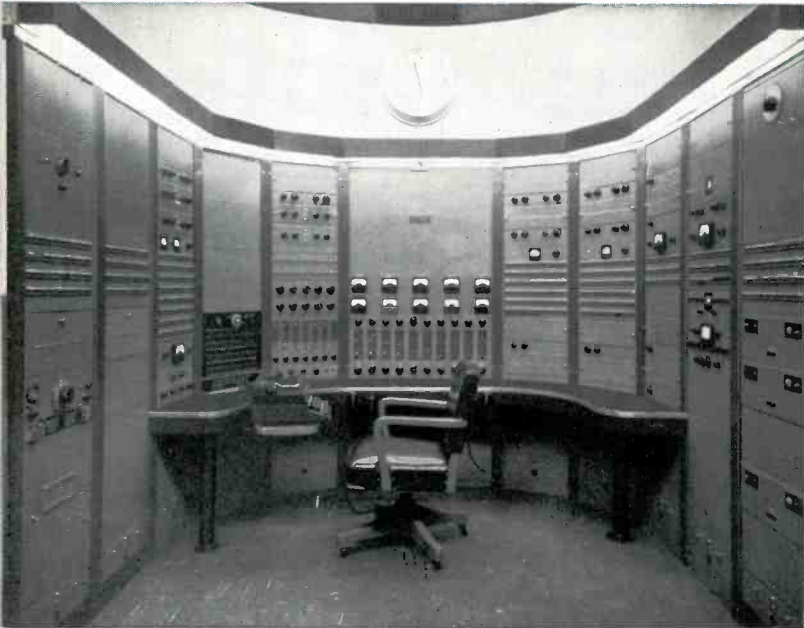

WNEW, New York. This master control installation—in WNEW's seven-studio lineup—is flanked on each side by five deluxe audio equipment racks. It has complete facilities for control and preset switching of seven studios to ten outgoing lines . . . and for feeding cues from any channel to any studio.

WMGM, New York. A deluxe custom-built studio console provides complete facilities for the control of WMGM's Studio "A" auditorium. The station's six modern studios and master control facilities feature deluxe custom-built audio.



WJAC, Johnstown, Pennsylvania. In this speech input layout, custom-built matching-end consoles contain auxiliary switches and controls. They are used in conjunction with a standard 76-series consolette to provide increased flexibility and convenience.



In addition to a comprehensive line of standard studio control equipment, RCA specializes in custom designing and building complete speech-input systems to meet individual needs of stations and networks. RCA engineers have worked closely with the nation's leading broadcast engineers in the design, production and installation of many custom equipments, a few of which are pictured on these pages. Studio-control systems such as these are tailor-made, combining just the right facilities for the control of program operations and the reproduction of high-fidelity sound.

Since no two broadcast stations have the same operating requirements, equipment needs will differ for each installation, ranging from special equipment for small and

medium-size stations to more complex systems for the largest network installation. In planning new installations, RCA "Custom-built" equipment service is available to every AM, FM, or Television station on almost any working agreement desired. RCA "Custom-built" service includes the services of an entire RCA engineering staff. Broadcast station engineers, in some cases, may wish to lay out and design the system themselves, complete with specifications. In these instances, RCA will provide specifically built units or modify standard equipment to meet these specifications in every detail. On the other hand, where stations desire, RCA engineers will study station requirements, make overall and detailed layouts, and draw up specifications for equipment needed.

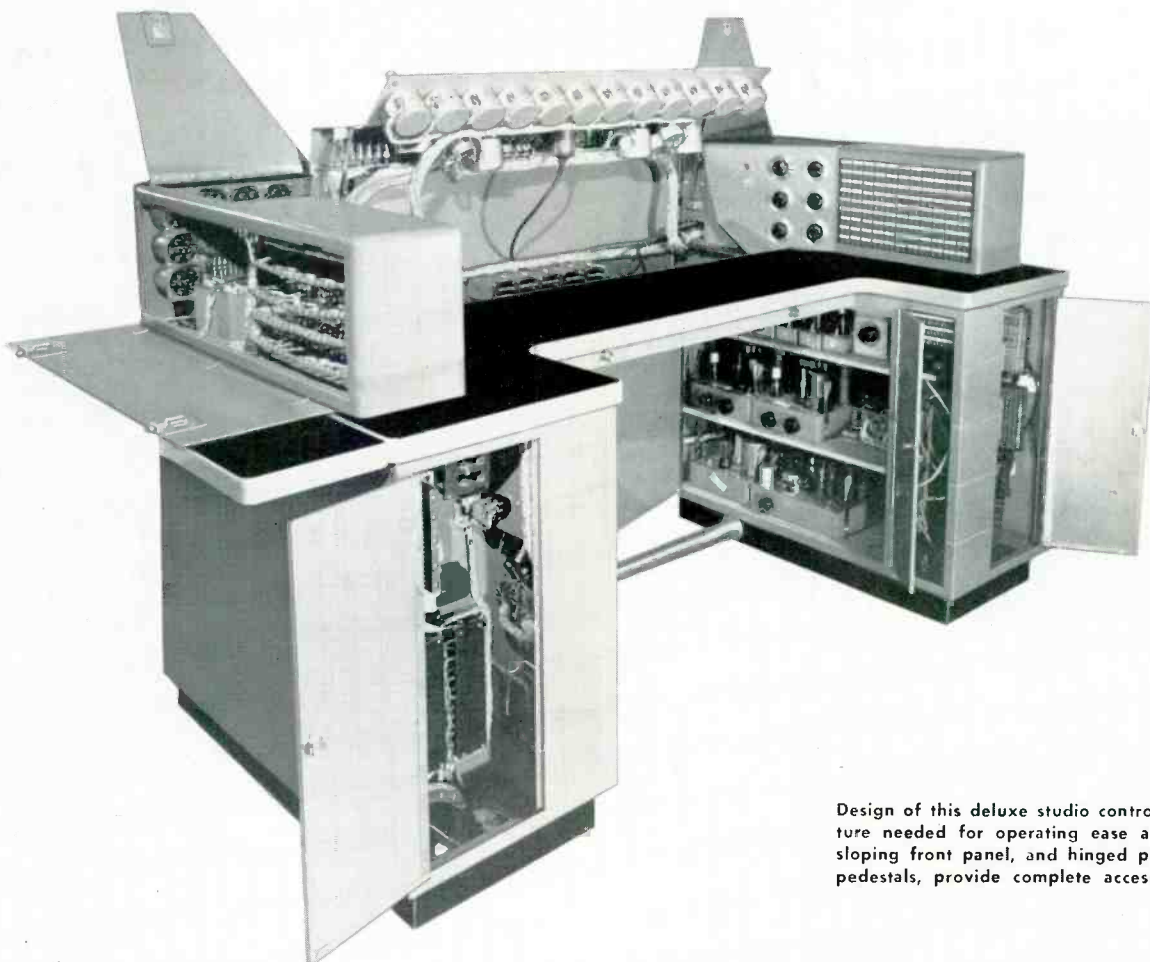

Design of this deluxe studio control console includes every feature needed for operating ease and convenience. The hinged sloping front panel, and hinged panel doors to all turrets and pedestals, provide complete accessibility to every component.



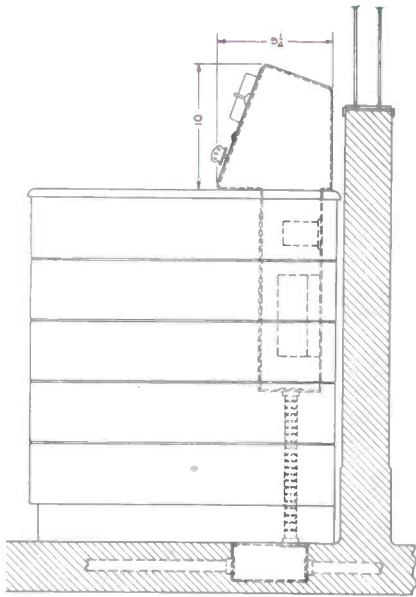

This cross-section view shows how the console at right was designed to permit some components to be mounted below the desk top. This results in small turret size and provides maximum visibility into the studio.

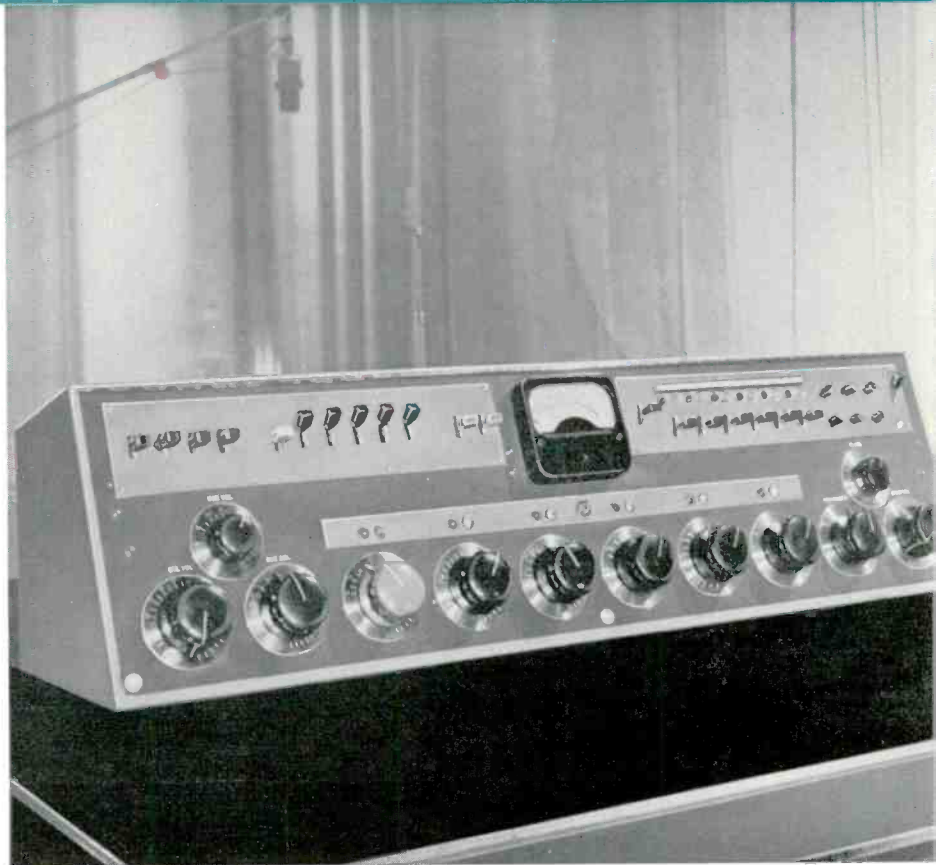

The studio console design shown above employs varied colored knobs and switch handles for easy and quick identification of individual controls. All escutcheons and dial plates are of attractive, long-wearing nickel silver.



Custom-built equipment can be designed for Television station requirements for audio, video and master control functions. Equipment for Television needs is discussed thoroughly under the heading "Custom Equipment for Television".

Pictured here is WOR-TV, New York. All programs are channelled through this master control room switching console. Eight master monitor housings accommodate facilities for six inputs and four outputs. Refinements include master or individual channel switching from "on-air" to "preset" circuits on each channel as well as simultaneous or independent video/audio switching on each channel.

# BROADCAST AMPLIFIERS

The RCA line of high-fidelity speech input amplifiers has been designed to provide stations with studio, recording and portable remote amplifiers which will offer the maximum in fidelity, flexibility, convenience and reliability. All amplifiers are suitable for FM having a uniform response to 15,000 cycles. Distortion and noise levels have been reduced to a very low value through careful engineering design and construction.

Attention is invited to gain and level references in this catalog, as follows:

db—refers to gain.

dbm—sine wave power measurement referred to 1 mw.

VU—refers to average program level as read on a standard VU meter. This value is subject to considerable variation from dbm but is generally considered 10 db below peaks.

Allowance must be made for program peaks to avoid amplifier overloading, for example, a pre-amplifier rated at +10 dbm should not be operated at more than 0 VU.

## Summary of RCA Broadcast Amplifier Characteristics

Type	Usage	Max. Gain db	Max. Input dbm*	Max. Output dbm*	Source Impedance Ohms	Load Impedance in Ohms	Type Mounting
BA-12A	Mic. Preamp. or Turntable Preamplifier	40	-22	+18	30/150/600	150/600	Chassis or Rack
BA-21A	Preamplifier	Matching 40	Matching -10	+18	37.5/150/600	150/600	Chassis or Rack
	Isolation Amp. with MI-11278-E or F Bridging Gain Control	Bridging 4	Bridging +40	+18	10,000	150/600	Chassis or Rack
BA-23A	Program Amp. Line Amp. Isolation Amp. Monitor Amp.	Matching 68 Bridging 25	Matching -10 Bridging 27	+30	150/600	150/600	Chassis or Rack
BA-24A	Monitoring or Recording Amplifier	104	-30	+40 dbm 10 watts	37.5/150/600	4/8/16/150/600	Chassis or Rack
BA-25A	AGC Program Amplifier	70	-25	+30	150/600	150/600	Chassis or Rack
MC-30	Monitoring or Recording Amplifier	50	Input 1 -4 to +32 v. Input 2 +10	+46 30 watts	Input 1 .13 meg. Input 2 .5 meg.	4/8/16/600	Chassis
MC-60	Monitoring or Recording Amplifier	90	Input 1 -4 to +32 v. Input 2 +10	+48 60 watts	Input 1 .13 meg. Input 2 .5 meg.	4/8/16/600	Chassis
BA-6A	Limiting Amplifier	54	Minimum at Verge of Limiting -24	+30	150/600	600	Chassis or Rack
BN-5A	Remote Portable Amplifier	90	-40	+18	150	600	Chassis
BN-6A	Remote Portable Amplifier	90	-40	+18	30/150	150/600	Portable Case
SA-10	Public Address Amp. Monitoring Amp.	Microphone 102 Phono 87	1.5 v. Phono	10 watts	Microphone† 85,000 Phono 250,000	4/8/16/500	Chassis

\* Reference level one milliwatt.

† May be converted to low impedance by using transformer MI-12399.

# PREAMPLIFIER POWER SUPPLY

## TYPE BX-21A

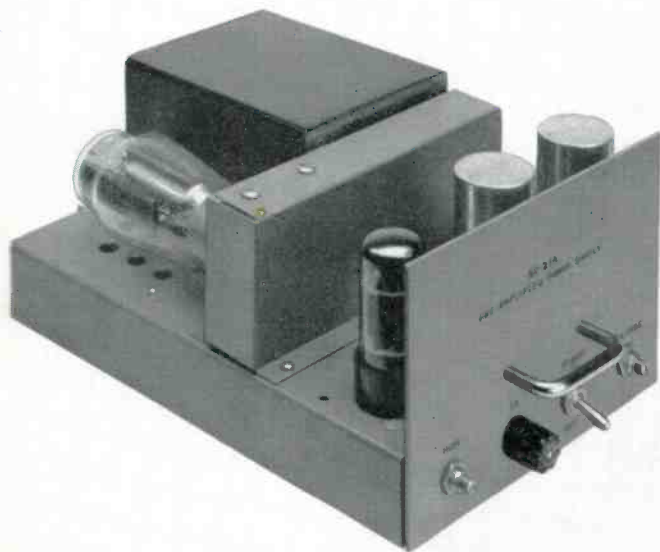

## FEATURES

- Regulated d-c output voltage
- Exceptionally low hum level
- Plugs into BR-22A Mounting Shelf
- Supplies up to 10 BA-21A Preamplifiers
- Heater supply hum balancing potentiometer

## USES

The Type BX-21A Preamplifier Power Supply is designed to provide d-c plate and a-c heater power for preamplifiers in which the hum level must be kept to a minimum. It is intended especially for use as a power supply for preamplifiers and isolation amplifiers such as the BA-21A.

## DESCRIPTION

The BX-21A is designed for operation on any a-c line voltage between 100 and 130 volts, 50 to 60 cycles. A two ampere, glass-enclosed, time-delay fuse is mounted on the front of the chassis. This fuse is unaffected by high transient currents.

The power supply consists of a full wave, high vacuum tube rectifier followed by resistance capacitance filtering. The output voltage is adjustable over a range of 245 to 295 volts and is maintained constant with variations in line voltage and loading by a series regulator tube in conjunction with a voltage reference and amplifier. This circuit also functions to reduce the ripple voltage. A metering voltage of 1 volt corresponding to nominal output voltage of 285 volts is available at connector plug for wiring to a meter panel.

## SPECIFICATIONS

Mounting..... Plug-in on BR-22A Mounting Shelf. Requires 2/5 of the shelf space. Two BX-21A Power Supply units may be mounted on one shelf with additional space for two BA-21A Preamplifiers or 1 BX-21A Power Supply and 6 BA-21A Preamplifiers may be mounted on one shelf.

Power Required..... 100 to 130 volts, 50-60 cycles, 130 watts

Fuse..... 2 ampere, type MDL

Power Output:

D-c..... 285 volts, up to 100 ma

A-c..... 6.3 volts, up to 6 amperes

Ripple Voltage..... 0.3 mv maximum

Tube Complement:

1—5R4GY, 1—6BX7-GT, 1—12AX7, 1—0A2

Dimensions and Weight:

Length ..... 12 1/2"

Width ..... 6 1/16"

Height ..... 4 21/32"

Weight ..... 16 lbs.

Finish ..... Light umber gray

Regulation..... 0.5% no load to full load and line voltage variation of 5%

Stock Identification (less Tubes)..... MI-11317

## Accessories

Tube Kit (complete tube complement)..... MI-11479

Panel and Shelf, Type BR-22A,  
Umber Gray (for 2 Power Supplies)..... MI-11597

Type BI-1B Meter Panel (for 17 amplifiers or power supplies)..... MI-11388



# PREAMPLIFIER AND ISOLATION AMPLIFIER

## TYPE BA-21A

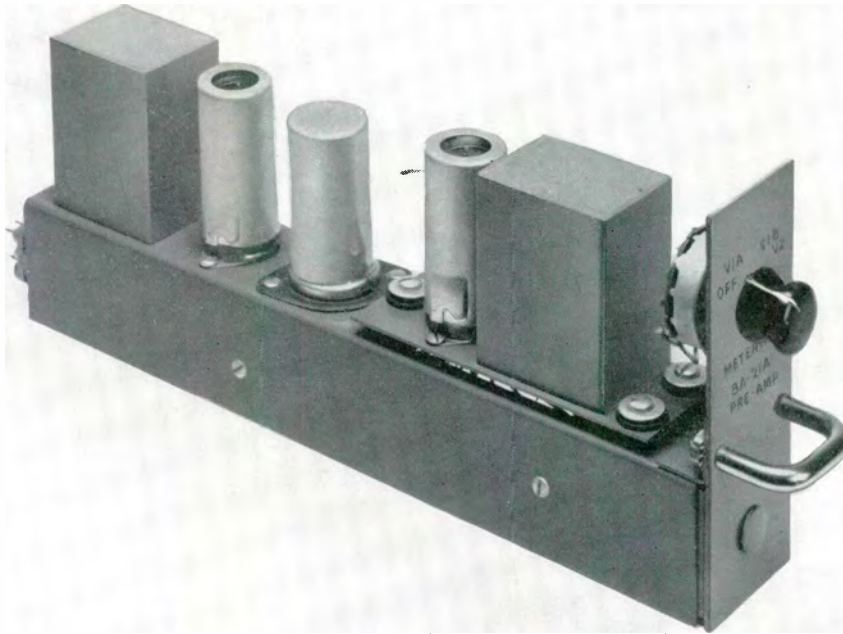

### FEATURES

- Etched wiring provides compact size and uniform performance
- Excellent frequency response  $\pm 1$  db 30 to 15,000 cycles
- Push-pull output provides high output with low distortion
- High output capability makes it useful as a booster or line amplifier
- 10 units may be mounted in one BR-22A Panel and Shelf . . . 5¼" high x 19" wide
- Hermetically sealed input and output transformers
- Improved plug-in unit and light weight affords ease of installation and removal

### USES

The BA-21A is an ideal unit for use as a microphone preamplifier, turntable preamplifier or booster amplifier. Its high output level makes it applicable as a line amplifier. It may also be used as an isolation amplifier operating from a zero to +40 vu feeder bus by the addition of an MI-11278-E or F Bridging Volume Control. The MI-11278-E control provides a knob for adjustments and the MI-11278-F control provides a screw-driver slot for adjustments. The small size of the BA-21A affords considerable mounting flexibility. It may be placed directly in a control console, control desk or transcription turntable cabinet. Where cabinet rack mounting is desired, one to ten of these units may be installed in a single BR-22A Panel and Shelf Assembly.

**DESCRIPTION**

The BA-21A has been designed to obtain high gain using one RCA MI-11299, selected 12AY7 tube in the input stage and one 12AY7 in the output stage. The tubes are mounted vertically and the first stage is shock mounted to prevent microphonics. The circuit is conventional with unloaded input transformer, resistance-capacitance coupling between stages and transformer output. The distortion and hum level has been reduced to a very low value through proper circuit design and through the use of stabilized feedback. Cross talk between units is -75 db, 30 to 15,000 cycles when mounted side by side and operated from the BX-21A Power Supply.

With the addition of the MI-11278-E or F volume control kit to provide a 10,000 ohm input, the BA-21A may also be used as a bridging or isolation amplifier. The MI-11278-E or F kits can be mounted on the BA-21A chassis and be adjusted by either knob or screw driver. The MI-11278-F can be used for panel mounting remote from the amplifier. As a bridging amplifier, the BA-21A has a maximum of 4 db gain with the volume control at minimum loss position and bridging a 600-ohm line. Approximately 80 db of isolation between output and input is obtained with the amplifier in this arrangement. A switch is provided for metering a portion of the cathode voltage of each tube when connected to a high-resistance voltmeter such as the Type BI-1B. The unit is designed to operate from the BX-21A Power Supply or its equivalent. The power requirements are 6.3 volts a-c or d-c at 0.6 amperes and 285 volts d-c at 10 ma. Up to ten BA-21A preamplifiers can be operated from one BX-21A Power Supply.

**SPECIFICATIONS**

**BA-21A AS PREAMPLIFIER:**

Source Impedance.....	37.5/150/600 ohms
Input Impedance (unloaded input transformer).....	Substantially above source impedance
Load Impedance (balanced or unbalanced).....	150/600 ohms
Maximum Input Level.....	-22 dbm
Maximum Output Level.....	18 dbm
Gain.....	40 db $\pm$ 1 db

**BA-21A AS ISOLATION AMPLIFIER (with MI-11278 Series Volume Control):**

Source Impedance.....	Up to 600 ohms
Input Impedance (through Volume Control).....	10,000 ohms
Load Impedance (balanced or unbalanced).....	150/600 ohms
Maximum Input Level, Volume Control at max.:	
Bridging 600 Ohms.....	14 dbm
Bridging 150 Ohms.....	20 dbm
Maximum Output Level.....	18 dbm
Maximum Gain.....	4 db

**BA-21A AS EITHER PREAMPLIFIER OR ISOLATION AMPLIFIER**

Frequency Response.....	$\pm$ 1 db 30-15,000 cps
Noise Level (Input and Output Terminated):	
Output.....	-82 dbm
Referred to Input.....	-122 dbm
Harmonic Distortion (18 db Output).....	0.75% at 30 cps 0.5% at 50 to 15,000 cps

**Tube Complement:**

1—Selected 12AY7, 1—12AY7	
Plate Power Supply.....	285 volts d-c at 10 ma
Filament Supply.....	6.3 volts a-c or d-c at 0.6 amps
Dimensions, Overall.....	Length 12 1/2", width 1 5/8", height 4 1/16"
Finish.....	Umber gray
Weight (unpacked).....	2 1/2 lbs.
Stock Identification (amplifier supplied less tubes).....	MI-11244-A

**Accessories**

Tube Kit (complete tube complement).....	MI-11482
Bridging Gain Control Kit (Screw-driver adjustment).....	MI-11278-F
(Knob adjustment).....	MI-11278-E
BX-21A Preamplifier Power Supply (furnishes filament and plate power for 1 to 10 BA-21A Preamplifiers).....	MI-11317
Type BI-1B Meter Panel (umber gray).....	MI-11388
BR-22A Mounting Shelf for rack mounting 1 to 10 preamplifiers or 1 power supply and 6 preamplifiers.....	MI-11597

**TYPICAL FREQUENCY RESPONSE  
MI-11244 PRE-AMPLIFIER  
TYPE - BA-21A**

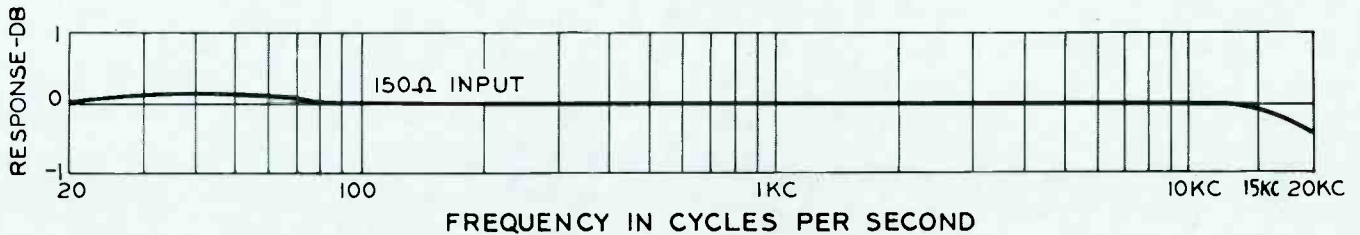

# UTILITY AMPLIFIER

## TYPE BA-12A

### FEATURES

- High output signal level allows use as line amplifier, turntable booster, microphone preamplifier or isolation amplifier (including line to line)
- Excellent frequency response— $\pm 1$  db 30 to 15,000 cycles
- Low distortion and hum level
- Self-contained power supply
- Compact — two BA-12A's may be mounted on one BR-2A shelf
- May be mounted inside turntable cabinet
- Plug-in electrolytic capacitors
- Plug-in chassis assures simplified servicing

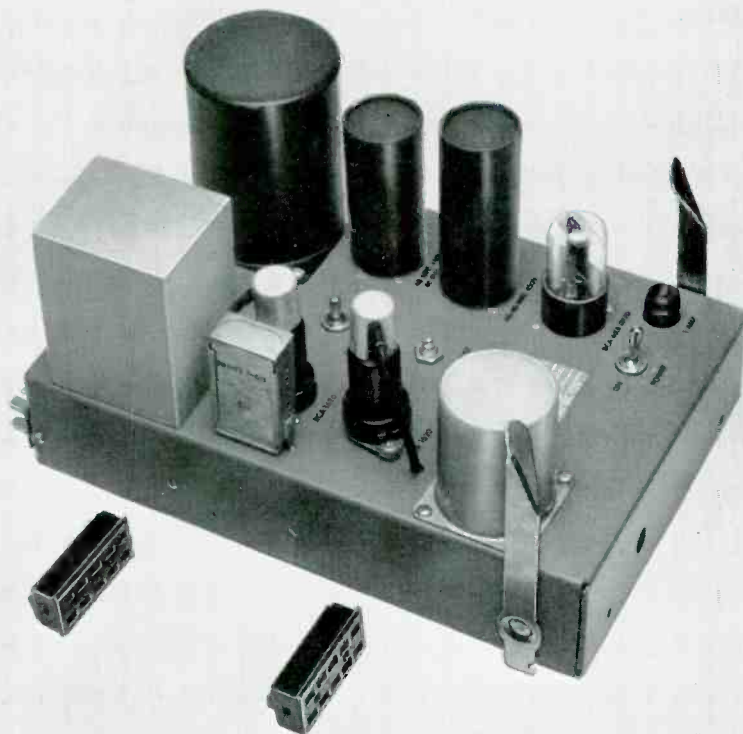

### USES

RCA's BA-12A is a versatile, two stage high-fidelity utility amplifier designed to serve as a microphone preamplifier, turntable booster amplifier, line amplifier or isolation amplifier—including line-to-line. Its high gain (40 db), extremely low noise level and low distortion make it an ideal unit for use as a microphone preamplifier, or turntable or booster amplifier. Its high output level makes it applicable for use as a line amplifier. It may also be used

as an isolation amplifier operating from a zero to  $+40$  vu feeder bus by the addition of an MI-11278-E or MI-11278-F Bridging Volume Control. Where cabinet rack mounting is desired, two of these units may be installed in a single BR-2A Panel and Shelf Assembly. When used as a turntable booster amplifier, the BA-12A may be mounted inside the turntable cabinet.

### DESCRIPTION

The BA-12A Utility Amplifier obtains high gain from two RCA 1620 tubes; one operated as a pentode, the other as a triode. The tubes are mounted vertically and the first stage is shock mounted to prevent microphonics. The circuit is conventional with unloaded transformer input, resistance-capacitance coupling between stages and transformer output. The distortion and hum level has been

reduced to a very low value through proper circuit design and through the use of stabilized feedback.

The amplifier is complete with built in a-c power supply which eliminates the need for external rectifiers. The hum and noise level has been kept to a very low value through the use of specially shielded power and audio transformers. A switch is provided for metering a portion of





# PROGRAM AMPLIFIER

TYPE BA-23A

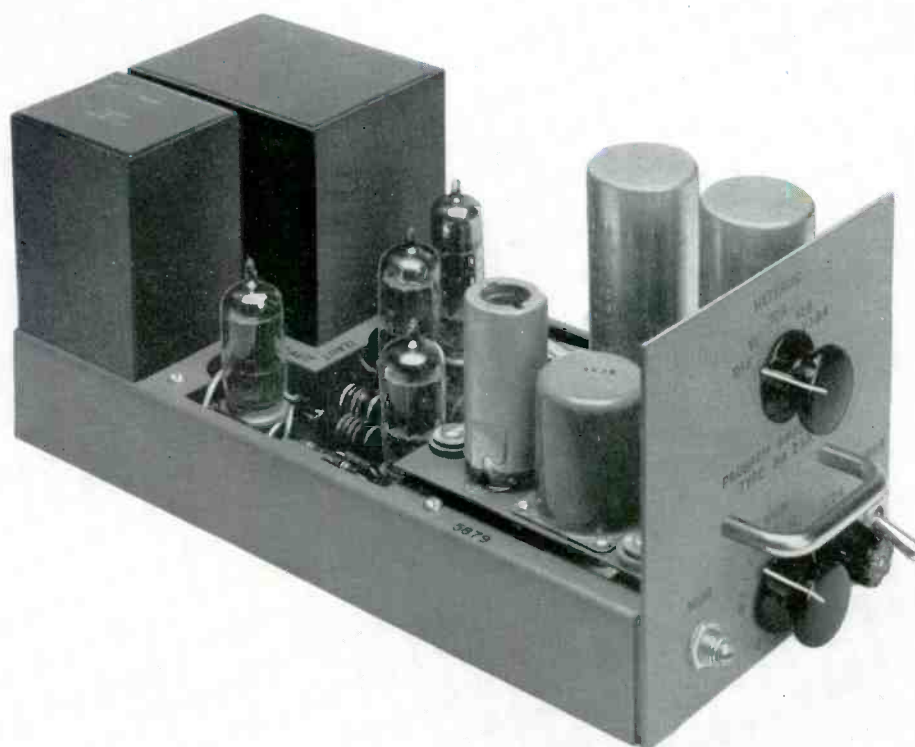

## FEATURES

- Etched wiring provides compact size and uniform performance
- Plug-in type for shelf mounting
- Maximum accessibility and dependable service
- Excellent frequency response
- High gain—low distortion—low noise level—high output
- Provision for tube metering
- Economical in price
- Small size
- Self contained power supply

## USES

The new BA-23A Program Amplifier is a very versatile high-fidelity amplifier designed for broadcast service. It incorporates special, high-quality, long-life components throughout and provides a maximum of accessibility to all circuit components. Its high gain and low distortion makes it ideal for use as: (1) Program or Line Amplifier, (2) Bridging Amplifier, (3) Isolation Amplifier.

The BA-23A is a plug-in type amplifier which has been designed for use with the BR-22A Mounting Shelf. This shelf permits quick and easy removal for servicing or interchanging units. The Type BR-22A Shelf provides mounting space for the 3 Type BA-23A amplifiers with space for one additional preamplifier.

**DESCRIPTION**

The BA-23A employs etched wiring to insure uniformity of performance. It uses resistors with plenty of wattage rating in reserve and hermetically sealed transformers. Thus long-life, trouble-free operation and extreme accessibility of parts is assured. Components on the printed circuit board can be easily replaced.

All connections to the BA-23A are made through a 15 prong connector at the back of the amplifier which plugs into a socket supplied with the amplifier. Connections are provided from each cathode circuit through a selector switch to terminals on the plug. These connections permit metering of tube conditions by means of a high resistance voltmeter such as the RCA Type BI-1B.

The BA-23A Program Amplifier has three stages of amplification with an additional phase splitter driving the push-pull-parallel output stage. The input stage utilizes a type 5897 low noise pentode. A 12AX7 twin triode is used as second stage and phase inverter. The push-pull output stage consists of two 12AU7 tubes having their sections connected in parallel. A 6X4 is used as full wave rectifier in the self-contained power supply.

The gain control follows the input transformer to permit high level input without overloading the input stage. A continuous composition type control is used in the MI-11246-A Program Amplifier, but space has been provided for a step type attenuator, if desired. A gain reduction of 15 db with a corresponding reduction in noise level may be obtained by changing a jumper on a voltage divider in the grid circuit of the second stage.

Inverse feedback is supplied from a tertiary winding of the output transformer to the cathode of the driver stage to stabilize gain and frequency response and to reduce distortion.

**SPECIFICATIONS**

Source Impedance.....	150/600 ohms balanced or unbalanced
Input Impedance (Matching).....	150/600 ohms
Input Impedance (Bridging).....	20,000 ohms
Load Impedance.....	150/600 ohms
Output Impedance.....	25/100 ohms
Maximum Input Level (Matching).....	-10 dbm
Maximum Input Level (Bridging).....	27 dbm
Maximum Gain (Matching).....	70 $\pm$ 1 db high, 55 $\pm$ 1 db low
Maximum Gain (Bridging).....	33 $\pm$ 2 db high, 18 $\pm$ 2 db low
Frequency Response.....	$\pm$ 1 db 30-15,000 cps
Harmonic Distortion.....	0.5% rms max. at 30 dbm output, 30-15,000 cps
Noise Level (at output).....	-47 dbm at 70 db gain -62 dbm at 55 db gain
Metering Voltage.....	1.0 volt
Tube Complement:	
1—Selected 5879, 1—12AX7, 2—12AU7, 1—6X4	
Power Required.....	100-130 v, 50/60 cps 30 w (Transformer taps at 105, 115 and 125 v)
Mechanical Dimensions:	
Length.....	Chassis 10 $\frac{3}{8}$ " , overall 12 $\frac{1}{2}$ "
Height.....	4 21/32"
Width.....	5"
Weight.....	9 lbs.
Finish.....	Light umber gray lacquer
Mounting.....	Plug-in mounting on MI-11597 Mounting Shelf, Type BR-22A. The BA-23A Amplifier requires 3/10 of the shelf space. Three BA-23A Program Amplifiers may be mounted on one BR-22A Mounting Shelf with space for one additional BA-21A Preamplifier.
Stock Identification.....	MI-11246-A

**Accessories**

Tube Kit.....	MI-11480
Meter Panel ,Type BI-1B (provides tube metering for 17 amplifiers).....	MI-11388
Mounting Shelf (for rack mounting of 3 BA-23A program amplifiers; requires 5 $\frac{1}{4}$ " of vertical rack space).....	MI-11597
Step Attenuator.....	MI-11751-2

**FREQUENCY RESPONSE  
MI-11246-A PROGRAM AMPLIFIER  
TYPE - BA-23A**

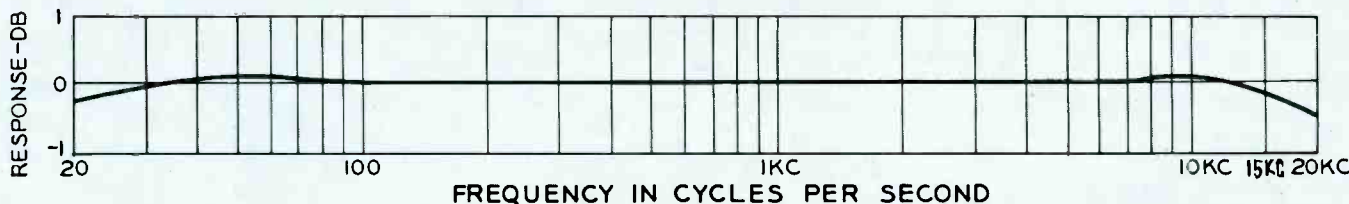



# MONITORING AMPLIFIER

TYPE BA-24A

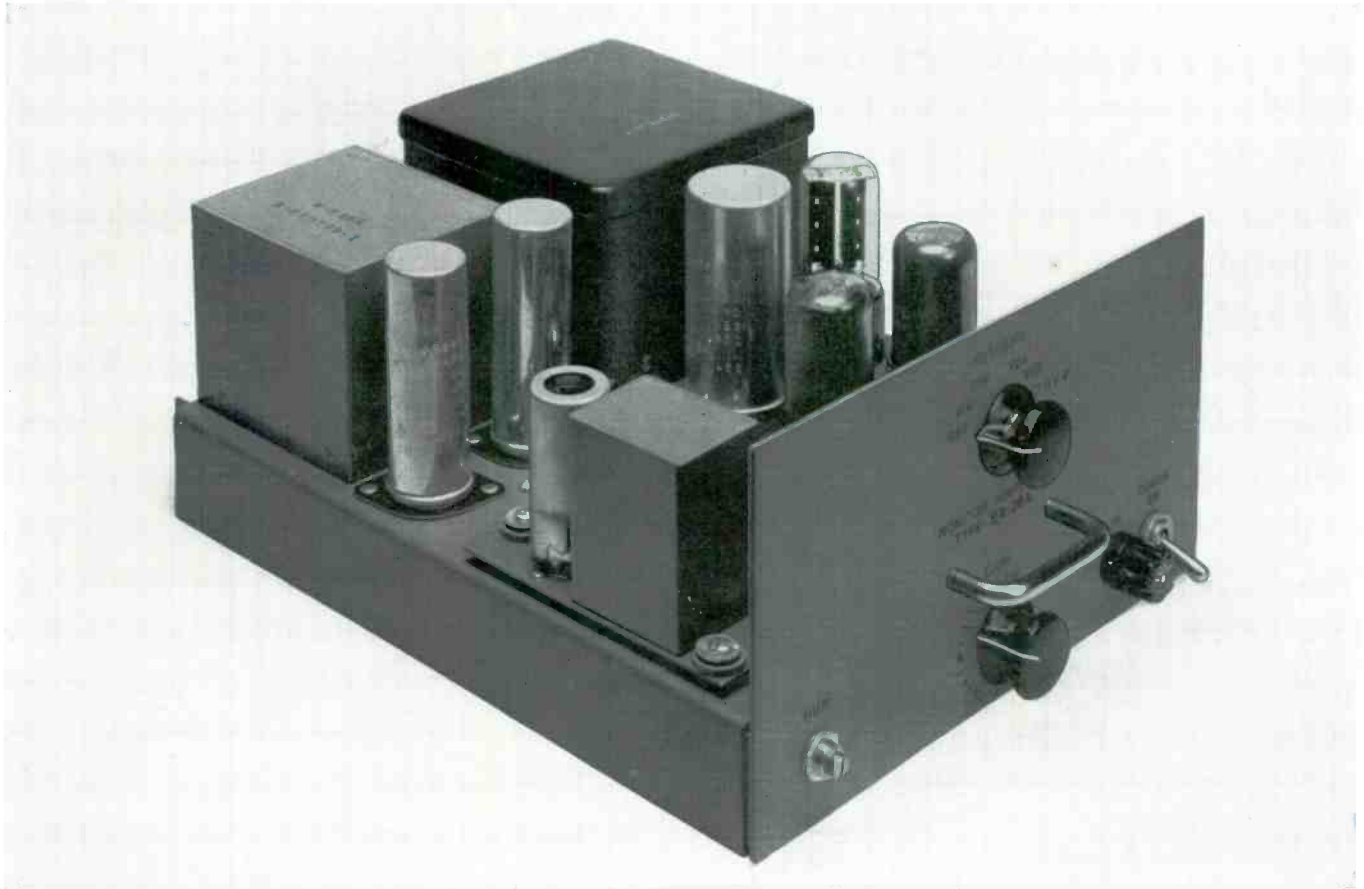

## FEATURES

- Etched wiring provides compact size and uniform performance
- Small size. Two units in 5¼" vertical rack space
- Frequency response 30 to 15,000 cycles
- Hermetically sealed transformers
- Suitable for emergency use as program amplifier
- Sufficient gain for direct operation of a speaker from turntable or microphone
- Plug-in mounting
- Self-contained power supply
- High gain—used directly in talk-back circuits, without preamplifier
- 8 watts output with low distortion—uses feedback
- Suitable for cabinet or shelf mounting
- Ideal for recording and playback applications
- Economical in price
- Tube metering circuits

**USES**

The BA-24A is a high fidelity, high gain flexible 8 watt amplifier suitable for monitoring, audition, recording, and talk-back applications or it may be used in emergencies as a program or line amplifier. It is ideal for transcription playback booths since its 105 db gain is sufficient to operate an (LC-1A) Speaker directly from the output of a (BQ-2B) Turntable. The high gain feature also allows its use directly in studio talk-back circuits without an intervening preamplifier. The BA-24A is an excellent recording amplifier being suitable for both high quality recording and playback applications. Two may be mounted in a type BR-22A Mounting Shelf. The BA-24A has a plug-in type chassis using multi-conductor plugs.

**DESCRIPTION**

A high quality, high gain amplifier suitable for driving a loudspeaker directly from a microphone or turntable output. It has four stages of amplification with an interstage gain control. A phase splitter drives the push-pull output stage. Negative feedback is utilized to reduce distortion, stabilize gain and frequency response. The power supply is self-contained. The hum level is reduced to a minimum through the use of well shielded transformers, low noise tubes and careful circuit layout. A metering switch on the front panel is provided to check the condition of the tubes, with the metering voltage of 1 volt brought out at the connector plug.

**SPECIFICATIONS**

Source Impedance.....	37.5/150/600 ohms
Input Impedance.....	Unloaded transformer, high in comparison with source impedance
Load Impedance.....	4/8/16/150/600 ohms
Output Impedance (approx.).....	1.3/1.8/3/21/78 ohms
Maximum Input Level.....	-30 dbm
Maximum Gain.....	104 db $\pm$ 2 db
Frequency Response.....	$\pm$ 2 db 30-15,000 cps
Maximum Output Level.....	10 watts (40 dbm)
Harmonic Distortion.....	Less than 1% 100-7500 cps
At 8 W (39 dbm output).....	Less than 2% 50-15,000 cps
Noise Level.....	-122 dbm referred to input (-18 dbm at output at 104 db gain)
Metering Voltage.....	1 volt
Tube Complement:	
1-Selected 12AY7, 1-12AX7, 2-6V6-GT/G, 1-5Y3-GT/G	
Power Requirement.....	100-130 volts, 50-60 cps, 70 watts
Dimensions:	
Length.....	10 $\frac{3}{8}$ " , 12 $\frac{1}{2}$ " overall
Width.....	8 $\frac{3}{8}$ "
Height.....	4 $\frac{21}{32}$ "
Weight.....	16 $\frac{1}{4}$ lbs.
Finish.....	Light umber gray
Mounting.....	Plug-in mounting on BR-22A Mounting Shelf. Requires half the shelf space (two amplifiers may be mounted on each shelf.)
Stock Identification.....	MI-11247

**Accessories**

BR-22A Mounting Shelf (mounts two BA-24A).....	MI-11597
Meter Panel (for 17 amplifiers) (BI-1B).....	MI-11388
Bridging (remote volume control).....	MI-11278-E or F
Tube Kit.....	MI-11481

**FREQUENCY RESPONSE  
MI-11247 MONITOR AMPLIFIER  
TYPE-BA-24A**

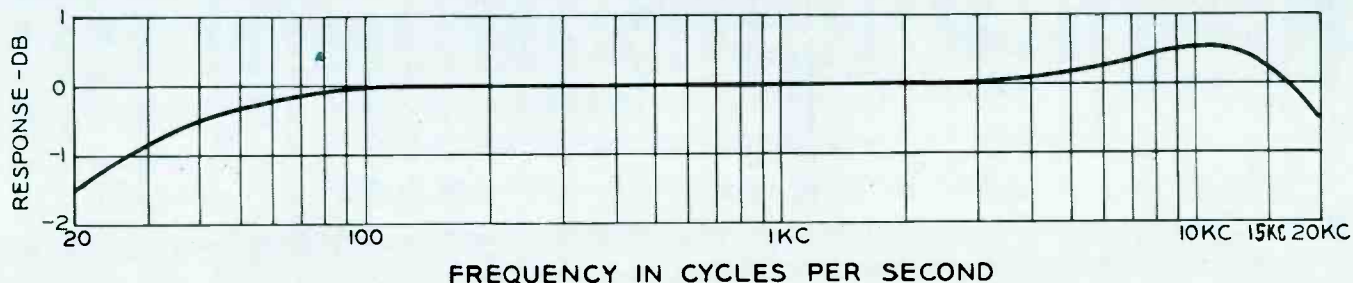

# A G C PROGRAM AMPLIFIER

TYPE BA-25A



## FEATURES

- Maintains nearly constant average output level over wide variations of average input level
- Feedback circuits provide excellent frequency response—low harmonic distortion
- Small, compact, plug-in construction
- Provides automatic fading or remote gain control
- Self-contained power supply
- Metering switch provides quick tube check
- Convenient front panel controls
- Stabilized bias voltage

## USES

The RCA Type BA-25A Automatic Gain Controlled Program Amplifier is an automatic level control unit designed to automatically control variations in audio program level. The unit is capable of maintaining a nearly constant average output level over wide variations of average input level. Such variations are often encountered when switching between the output of projectors, turntable pre-amps and other sound sources.

The amplifier may also be used in conjunction with an external bias source for remote gain control or automatic fading. This permits unattended remote audio operation. It may also be used as a program line compressor or as a master gain control for program line. The BA-25A may be used as a microwave input audio control, as an automatic fader control, or as a straight program amplifier without level control by removal of one tube disabling the automatic level control circuit.



DESCRIPTION

The new BA-25A Automatic Gain Controlled Program Amplifier is a small, compact amplifier mounted on a plug-in chassis for easy maintenance and replacement. Two amplifiers can be mounted on the MI-11597 Mounting Shelf which requires but 5.25 inches of rack space.

The circuitry of the BA-25A is straightforward. The input signal is applied through an input transformer and input level control to a phase splitter. The phase splitter drives a push-pull variable gain amplifier which utilizes a type 6386 remote-cutoff twin triode tube. The gain of this stage depends on the bias voltage, the more negative, the lower is the gain. The output of the variable gain stage is fed to a push-pull voltage amplifier and a push-pull parallel output stage. Negative feedback is applied over the output and driver stages. A portion of the output signal is supplied to a rectifier tube. An adjustable positive bias on this tube delays rectification of the signal until the output level exceeds the "threshold" value.

The rectified current is filtered through a resistance-capacitance network having a fast charge and slow discharge time constant. This voltage, which is negative with respect to ground, is applied as a bias voltage to the grids of the remote cut-off tubes. As the output level increases, the bias voltage becomes more negative, reducing the gain of the amplifier and thus reducing the increase in output level. This constitutes a closed loop system which tends to maintain a nearly constant output level as long as the input signal is sufficient to reach the threshold of compression.

Below the threshold level, which is adjustable by varying the rectifier delay bias, the amplifier is linear and the output level is therefore proportional to the input level. Above the threshold level, the increase in output level (expressed in db) is less than the increase in input level (also expressed in db). The ratio of the increase in input level to the increase in output level is the compression ratio. This compression ratio is a function of the threshold level. The higher the setting of the threshold level, the higher is the compression ratio.

For automatic fading or remote gain control, the negative bias voltage for the remote cut-off stage may be supplied by an external source. Since the gain of the remote cut-off stage is a function of the cathode current, the voltage drop across the cathode resistor of either section of the variable gain stage may be used as an indication of the amount of gain reduction.

A metering switch is provided on the BA-25A which measures the cathode current of the amplifier tubes to obtain a quick indication of the tube conditions. Other controls,

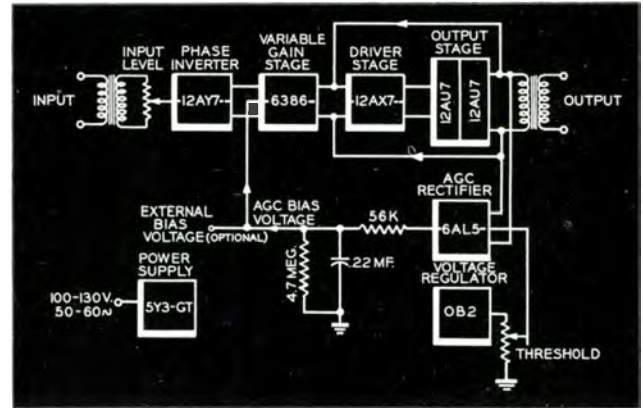

Simplified Block Diagram of BA-25A AGC Program Amplifier

all located on the front panel include: a hum control for adjusting the hum level to a minimum, the power switch, threshold level control, and input level adjustment control. An external attenuator may be used for adjusting the output level where necessary.

SPECIFICATIONS

Input Impedance.....	150/600 ohms
Source Impedance .....	150/600 ohms
Output Impedance.....	30/120 ohms
Load Impedance.....	150/600 ohms
Maximum Input Level.....	-25 dbm
Maximum Output Level.....	+ 30 dbm
Maximum Noise Level, Output.....	-46 dbm
Frequency Response.....	30-15,000 cps, ±1 db
Harmonic Distortion.....	30-15,000 cps, less than 1%
Gain, Maximum Below Verge of Compression.....	70 db ±1 db
Threshold of Compression:	
Compression Ratio.....	3:1                      Output Level..... 5 dbm
	4:1                      14 dbm
	5:1                      18 dbm
	6:1                      21 dbm
Attack Time Constant.....	12.5 milliseconds
Recovery Time Constant.....	1 sec.
Tube Complement:	
1—OB2, 1—5Y3-GT, 1—6AL5, 2—12AU7, 1—12AX7, 1—MI-11299 selected 12AY7, 1—6386.	
Power Requirements.....	100-130 volts, 50/60 cycles, 55 watts
Dimensions, Overall.....	12 1/2" long, 8 3/8" wide, 4 21/32" high
Finish.....	Light umber gray
Weight .....	15 lbs.
Stock Identification .....	MI-11434

Accessories

Tube Kit .....	MI-11487
Mounting Shelf, Type BR-22A, for 2 Amplifiers.....	MI-11597
Meter Panel, Type BI-1B, for 17 Amplifiers.....	MI-11388

# MONITORING AMPLIFIERS

MI-11229-A (30 WATT) AND MI-11236-B (60 WATT)

## FEATURES

- Low distortion—less than 1%
- Compact, lightweight units
- High quality components
- Low noise level
- Low phase shift distortion
- Simplified servicing



30 Watt Amplifier, MI-11229-A.

## USES

The McIntosh Model MC-30 and MC-60 amplifiers find particular application where higher power amplifiers are desired. They provide high efficiency and low distortion features for use as broadcast monitoring or recording amplifiers or as general purpose amplifiers.

## DESCRIPTION

Both the 30-watt, MC-30 and 60-watt, MC-60 Type amplifiers feature a unity coupled circuit with bifilar output transformer as used in all McIntosh power amplifiers. This new circuit provides practically 100 percent coupling between primary windings of the output transformer by winding the primary wires together, or bifilarly. The high efficiency of the class "B" amplification can be used for high quality performance. Waveform distortion due to switching transients between each half of the class "B" amplifier is eliminated at all frequencies.

By bringing the output tubes electrically four times closer together the impedance is  $\frac{1}{4}$  that of ordinary amplifier circuits. The coupling to the secondary is improved by a similar factor of 4 to 1 since the primary to secondary

turns ratio has been reduced 2 to 1. The  $\frac{1}{2}$  cathode  $\frac{1}{2}$  plate loading provides a feedback factor of 12 db which with additional loop feedback, offers new low distortion and exceptional stability. They are able to provide less than  $\frac{1}{2}$  of 1% harmonic distortion and less than  $\frac{1}{2}$  of 1% intermodulation distortion for any frequency or combination of frequencies, throughout the audible range, even at full power output.

Both the MC-30 and MC-60 amplifiers are designed to power the C-4 and C-8 type McIntosh Preamplifiers. The C-4 equalizer preamplifier is designed as the control center of the sound reproducing system. Five front panel controls regulate selector, compression, bass, treble, and volume. Circuit arrangement and techniques bring complete freedom from impulse type of distortion. There are five input channels, two of which are equalized for use with magnetic cartridges. Stable feedback amplification permits full adjustment of either the treble or bass controls without any amplifier instability whatsoever. The preamplifier normally operates off the amplifier, but can be supplied as a self-powered unit.



60 Watt Amplifier, MI-11236-B.

The C-8 is a professional audio compensator, self-powered, and providing three auxiliary 110 volt outlets so that record player, tuner, power amplifier and compensator can all be controlled from the master on-off switch. There is one tape output, and one auxiliary output in addition to the regular amplifier output. A variable load resistor, calibrated from 1000 ohms to 100,000 ohms, to terminate any magnetic cartridge, produces optimum performance at any prevailing condition. A switch provides amplitude equalization for cartridges, and five input channels each with level controls, provide proper connection with any possible signal source. The C-4 and C-8 are regularly mounted in a chassis, but also can be procured with either blond or mahogany cabinets.

**SPECIFICATIONS**

**Model MC-30 (30 Watt)**

Power Supply.....	117/125 volts, 50/60 cycles
Power Consumption.....	155 watts at 30 watts output 105 watts at zero signal output
Power Output.....	30 watts continuous
Frequency Response.....	20 to 30,000 cycles $\pm 1$ db at 30 watts output 15 to 50,000 cycles $\pm 5$ db at 30 watts output 10 to 100,000 cycles $\pm 1$ db at 15 watts output
Input Level:	
Input #1.....	0.5 volt to 30 volts with gain control
Input #2.....	2.5 volts
Harmonic Distortion.....	Less than $\frac{1}{3}\%$ at 30 watts output or less, 20 to 20,000 cycles
Intermodulation Distortion.....	Less than $\frac{1}{2}\%$ if instantaneous peak power is below 60 watts for any combination of frequencies 20 to 20,000 cycles.
Noise Level.....	90 db or more below rated output
Input Impedance.....	0.13 meg. for 2.5 volt input and 0.5 meg. for 0.5 volt input from 20 cycles to 40 Kc
Output Impedance.....	4, 8, 16 and 600 ohms (600 ohm is balanced to ground)
Phase Shift.....	20 cycles $3^\circ$ , 20,000 cycles $9^\circ$
Tube Complement:	
Rectifier.....	5U4-GA
Pre-Amp.....	12AX7
Phase Inverter.....	12AU7
Voltage Amplifier.....	12BH7
Driver.....	12AX7
Output.....	2-1614
Dimensions.....	Length $13\frac{1}{8}$ " , Width 8" , Height 8"
Net Weight.....	30.5 lbs.
Finish.....	Chrome and black
Stock Identification, with Tubes.....	MI-11229-A

**Model MC-60 (60 Watt)**

Power Supply.....	117/125 volts, 50/60 cycles
Power Consumption.....	280 watts at 60 watts output 155 watts at zero signal output
Power Output.....	60 watts continuous
Frequency Response.....	20 to 30,000 cycles $\pm 1$ db at 60 watts output 16 to 60,000 cycles $\pm 5$ db at 60 watts output 10 to 100,000 cycles $\pm 1.0$ db at 30 watts output
Input Level:	
Input #1.....	0.5 volts to 30 volts, with gain control
Input #2.....	2.5 volts (for use with McIntosh preamplifiers)
Harmonic Distortion.....	Less than 0.3% at 60 watts output or less, 20 to 20,000 cycles
Intermodulation Distortion.....	Less than 0.5% if instantaneous peak power is below 120 watts
Noise Level.....	90 db or more below rated output
Input Impedance.....	0.5 meg for 0.5 volt input and 0.13 meg for 2.5 volt input, 20 cycles to 40 kc
Output Impedance.....	4, 8, 16 and 600 ohms (600 ohm is balanced to ground)
Phase Shift.....	$\pm 8^\circ$ 20 to 20,000 cycles
Tube Complement:	
Rectifiers.....	2-5U4-GA
Preamplifier.....	12AX7
Phase Inverter.....	12AU7
Voltage Amplifier.....	12BH7
Driver.....	12AX7
Outputs.....	2-6550
Dimensions.....	$14\frac{1}{4}$ " long, 10" wide, 8" high
Net Weight.....	43 lbs. approx.
Finish.....	Chrome and black
Stock Identification.....	MI-11236-B

**Accessories**

Preamplifier.....	C-4
Preamplifier.....	C-8



# LIMITING AMPLIFIER

## TYPE BA-6A

### FEATURES

- Prevents distortion and adjacent channel interference
- Economical in price—high-quality performance
- Provides for a more effective use of transmitter power
- Compact, plug-in unit—requires little rack space
- Complete rotary switch selection of metering of all key functions provided

### USES

The BA-6A Limiting Amplifier has been designed to provide economical, yet high-quality operation in the speech input channels of FM and AM broadcast and TV sound transmitters. It serves as an automatic means of limiting the audio signal peaks to a certain pre-determined level thereby preventing overmodulation or overloading with its consequent distortion and adjacent channel interference. This amplifier also provides for a more effective use of transmitter power by allowing the system to be operated as near maximum output as possible. It raises the average percentage modulation level several db without appreciably increasing the harmonic distortion.

The limiting characteristics of the BA-6A also readily adapt it for use in recording applications. For this use, it prevents over-cutting of the recording disc on heavy passages of music or speech and permits a marked improvement in the signal to noise ratio. Thus, the BA-6A Limiting Amplifier is an essential item for the successful operation of every broadcasting station and recording studio.

### DESCRIPTION

The BA-6A is a balanced, three-stage amplifier which uses commonly available tube types that do not require special selection or matching. The use of high-quality components and the straightforwardness of design, employing only 9 tubes including rectifier and voltage regulator, insure a maximum degree of reliability. Fewer tubes, fewer types



(only 6) and fewer stages of simplified design result in lower tube costs, low initial cost and reduced power input requirements.

The BA-6A Limiting Amplifier also incorporates those features which are found in other RCA high-quality broadcast audio amplifiers. The amplifier with its self-contained power supply is constructed on a plug-in chassis for shelf mounting and is therefore readily removable for inspection and service. All controls, tubes, and plug-in capacitors are accessible from the front.

A rotary selector switch permits use of the four-inch illuminated meter for measuring gain reduction, the cathode current of all amplifier tubes, tube balance and d-c filament voltage. Plate and heater power are available for operating a pre-amplifier in applications where additional gain is required. The rotary switch (BAL-LIM) provided on the front panel also permits selection of a filter with either a single or dual time constant. In the "single" position the attack time is 0.0006 seconds. In the "dual" position the recovery time is lengthened to two seconds on sustained peaks.

The input transformer matches a 600 and 150-ohm line. A dual attenuator controls the input signal which is applied to the control grids of two 6SK7 remote cut-off pentodes of the variable gain stage. To minimize "thump" over a wide range of gain reduction, both the screen and cathode voltages of these tubes are adjustable and thus any pair of tubes may be balanced over the entire operating range. Switches on the front panel permit making the balancing adjustments quickly and without external equipment by applying an internal 60-cycle signal to the 6SK7 grids and using the front-panel meter to indicate balance.

As an additional means of maintaining balance, the first stage is transformer coupled to the second stage. The output stage is capable of delivering 10 watts to an adjustable 600-ohm output attenuator pad which is calibrated in 1 db steps. A continuous fine output adjustment is also provided to set the output level exactly. This is an important feature since a fraction of a db change in output level might result in a large increase of distortion in certain types of transmitting equipment. A full wave rectifier, connected to the output stage through coupling capacitors and isolating resistors, provides the gain control voltage.

Step-by-step input and output volume controls are provided. These controls are equipped with "dbm" scales to indicate input and output levels at the verge of compression. Auxiliary adjustable controls are: (1) hum balance, (2) zero adjustment of gain reduction meter scale, (3) vernier control for output level, and (4) balance, (5) heater voltage. It also provides two positions for balancing of tubes in the first stage. A power switch and fuse are provided. For rack mounting the MI-11599 Shelf should be used. A special umber gray door panel with meter cut-out is supplied with the BA-6A amplifier.

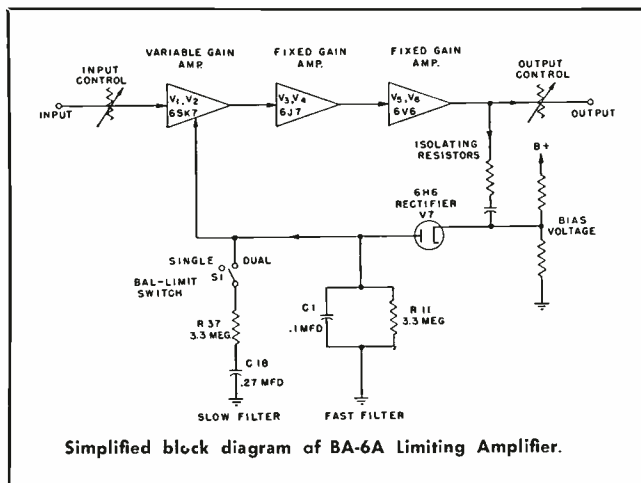

SPECIFICATIONS

Source Impedance.....600/150 ohms

Input Impedance.....600/150 ohms, balanced or unbalanced

Frequency Response:  
 (30 to 15,000 cps, 1000 cps reference)  
 Be'ow verge of limiting.....±1 db  
 Up to 20 db gain reduction.....+1 to -2 db

Input Level:  
 Minimum (at limiting verge).....-24 dbm  
 Maximum .....+14 dbm

Output Level:  
 Maximum (limiting off) at 1000 cps.....38.5 dbm  
 At verge of limiting with output controls in  
 minimum attenuation position.....29.5 dbm ±1 db

Gain.....54 db ±1 db at 1000 cps, 600-ohm source  
 to 600-ohm load

Gain Controls:  
 Input.....20 steps, 2 db per step  
 Output.....20 steps, 1 db per step and fine adjustment

Signal-to-Noise Ratio.....83 db at verge of limiting

Harmonic Distortion (Total RMS) 12 db gain  
 reduction (100-15,000 cycles).....Less than 1%  
 No gain reduction, 30 dbm output.....Less than 0.6% 50-15,000 cps  
 Less than 1.2% 30 cps

Limiting Characteristic:  
 Output at verge of limiting.....29.5 dbm ±0.5 dbm, output control  
 in maximum gain position  
 Compression ratio above verge of limiting.....20 db into 2 db

Time Constants:

	Attack	Release
Single .....	600 microsec.	0.33 sec.
Dual, Fast Action.....	600 microsec.	0.33 sec.
Dual, Slow Action.....	0.9 sec.	2 sec.

Tube Complement (not included with amplifier):  
 2-6SK7, 2-6J7, 2-6V6-GT, 1-6H6, 1-OD3/VR150, 1-5R4GY

Power Required (Transformer taps provided for  
 105, 115, and 125 v.) (100 to 130 v., 50-60 cy.).....105 watts

Dimensions:

Chassis.....16<sup>3</sup>/<sub>16</sub>" long, 11<sup>3</sup>/<sub>4</sub>" wide, 3" high  
 Overall.....16<sup>3</sup>/<sub>16</sub>" long, 14" wide, 7<sup>5</sup>/<sub>16</sub>" high

Weight .....37 lbs.

Finish.....Dark umber gray

Mounting.....Plug-in mounting on MI-11599 Shelf

Stock Identification (including front panel less tubes).....MI-11225

Accessories

Tube Kit (complete tube complement).....MI-11289

Shelf .....MI-11599



# SINGLE CHANNEL REMOTE AMPLIFIER

## TYPE BN-5A

### FEATURES

- Portable, compact and completely self-contained for a-c operation
- Economy type unit—can be left at locations for future broadcasts
- Excellent frequency response  $\pm 1$  db from 50 to 15,000 cps
- Provides space for additional microphone input and switch for conversion to a two input remote amplifier
- Permits mounting of VU meter if desired



### USE

The Type BN-5A Single Channel Remote Amplifier is a lightweight, portable unit designed to amplify low level signals for transmission over a telephone line to the broadcast studio. The amplifier is an economical unit suitable for permanent or semi-permanent installation in churches, hotels, department stores, night clubs, restaurants, studio, or other site for future broadcasts. It finds a ready use any place where a high gain booster amplifier is needed.

The BN-5A is completely self-contained for a-c operations. Two additional features may be installed if desired. A second microphone input may be installed on the rear apron with a switch for alternating two microphones. Only one microphone should be used at a time. A VU meter may be installed on the plain side of the amplifier cover, or if permanent installation is not desired, the meter may be placed across the line output posts.

### DESCRIPTION

The BN-5A Single Channel Remote Amplifier is a five stage amplifier including a phase inverter and push-pull output stage. The amplifier and its power supply are mounted on a 5" x 10" chassis with bottom plate and cover. The amplifier section has a removable etched wiring board on

one side of which numerous components are mounted, and, on the other, the etched circuit. A headphone jack for monitoring the output is provided on the chassis together with the "OFF-ON" switch, gain control, and replaceable fuse rated  $\frac{1}{2}$  amp. and 250 volts. The a-c power cord and plug is attached at the rear of the chassis for operation from a suitable wall outlet.

The BN-5A has an interstage gain control, between the first and second stages of the amplifier, which permits an input level as high as  $-30$  dbm to be amplified to line level without exceeding the distortion rating. The push-pull output stage provides good efficiency and low distortion operation. Balanced feedback is obtained from a tertiary winding on the output transformer thereby allowing the secondary to be ungrounded. A 6 db isolation pad is inserted between the transformer secondary and the line output terminals. A bridging resistance from the output to the phone jack provides an output monitoring facility. The BN-5A is shipped connected for operation from 150-ohm balanced source into a 600-ohm balanced line.

Tubes for the BN-5A Remote Amplifier must be ordered separately. The Tube Kit, MI-11485 includes an RCA selected 12AY7 (MI-11299) Input Stage and Voltage Amplifier. The MI-11485-A Tube Kit is identical except that the 12AY7 tube, not selected, is used for applications not critical to noise. Two tube shields and four springs are



Rear view of BN-5A Amplifier with cover removed showing components mounted on removable etched wiring board and self-contained power supply.

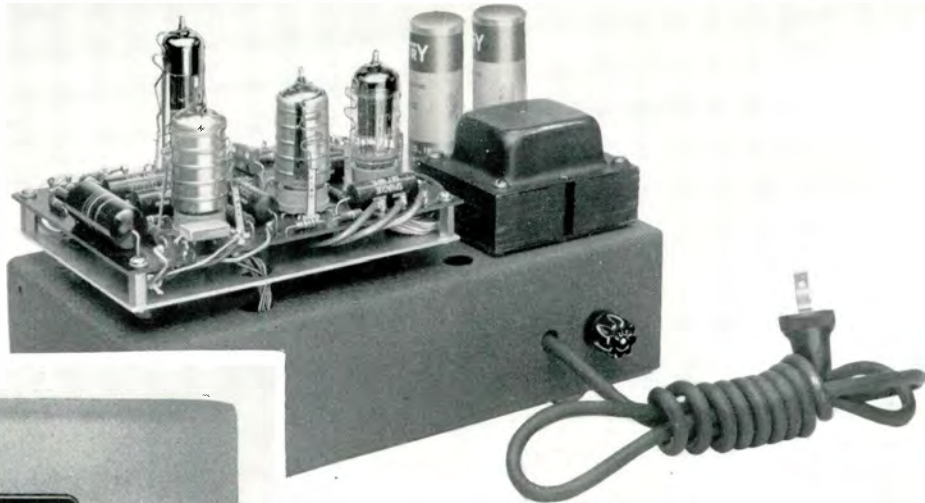

Single Channel Remote Amplifier showing accessory VU meter which may be mounted by the user on non-louvered side of amplifier cover.

supplied with the amplifier. Anchor lugs are mounted on the circuit board, two for each socket. These lugs hold the springs in position to keep the tubes in place under conditions of unusual vibration.

A VU meter, such as the standard Simpson Meter, may be purchased separately and mounted directly in the center of the non-louvered side of the amplifier cover. The microphone input is standard for any low impedance microphone. Low impedance headphones may be plugged into the jack for monitoring the output. In some applications where monitoring would not be required or possibly not convenient, the level may be preset and the program can be monitored at the studio.

**SPECIFICATIONS**

Source Impedance.....	150 ohms balanced or unbalanced
Load Impedance.....	600 ohms
Frequency Response.....	$\pm 1.5$ db from 50 to 15,000 cps
Gain:	
MIC Input to Line Out.....	90 $\pm 2$ db
MIC Input to Phone Jack.....	70 $\pm 4$ db
Signal to Noise Ratio (-50 dbm input).....	-65 dbm
Harmonic Distortion (at output level of 18 dbm with GAIN set at 70 db approximately).....	Less than 1.5% at 50 cps; Less than 1.0% from 100 to 15,000 cps
Tube Complement:	
1—Selected 12AY7, 1—12AX7, 1—12AU7, 1—6X4	
Dimensions.....	10" wide, 5" deep, 8.62" high
Weight .....	9 1/4 lbs.
Finish.....	Wrinkle, two tone umber gray
Input Connector.....	Type XL

**Equipment Supplied**

Type BN-5A Single Channel Remote Amplifier, less tubes but including Instruction Book (IB-24787).....	MI-11249
---	----------

**Accessories**

Tube Kit with Selected Input Stage and Voltage Amplifier.....	MI-11485
Tube Kit with Unselected Input Stage and Voltage Amplifier.....	MI-11485-A
Note: This tube kit with unselected 12AY7 tube may be used when maximum uniformity of characteristics and minimum of microphonics, hum and distortion are not required.	
VU Meter .....	Stock #53064
Microphone Input Connector.....	MI-11089-A

# TRANSISTOR PORTABLE REMOTE AMPLIFIER

TYPE BN-6A



## FEATURES

- Transistors used throughout
- Utilizes long life mercury batteries
- Alternate germanium rectifier a-c power supply
- High level mixing—four separate channels
- Etched wiring, functionally styled package, extremely light weight
- New RCA Type 2N175 low-noise transistors serve as input amplifiers
- Amplified cue signal from studio
- Manual selection of battery or a-c supply—positive selection for desired mode of operation

## USES

The BN-6A Transistor Portable Remote Amplifier is an extremely lightweight, four channel amplifier designed especially for remote broadcast use. It affords amplification and control facilities for broadcast programs remote from the studio, amplifying low level signals to a level suitable for transmission over a telephone line to the studio. Four separate input channels are provided that can be operated either single ended or balanced. Complete cueing and monitoring facilities are included. The equipment uses transistors and germanium diodes throughout, and is completely self-contained for a-c or battery operation.

## DESCRIPTION

The new RCA BN-6A Transistor Portable Remote Amplifier is a single, functionally styled unit in which an etched wiring board including all amplifier components and transistors, controls, batteries and alternate a-c power supply are all contained in a portable carrying case. A carrying handle is supplied with the amplifier which, when pulled forward, locks into position in front of the control panel. The handle may be retracted by pushing it down and under the chassis where it locks in position hidden from view. In this position two or more amplifiers may be stacked. When operating a single amplifier, the handle may be brought to the mid position where it locks and offers an inclination of the control panel 15° from the perpendicular to the table surface for easy operation. The amplifier weighs only 15 pounds.

All controls are located on the front panel including an illuminated VU meter, four mixer controls, the master control, phone jack, cue switch, and power switch. For ease of servicing the cover may be lifted from its catch at the rear and swung up on its hinges away from the chassis exposing all components. Batteries are accessible through the battery storage chamber located on the right hand side panel of the chassis. A rear panel features a twist lock type a-c connector located on the right of the



panel with the fuse holder directly above it. Clips are provided for securing the 8-foot long a-c power cord when not in use. Binding posts are provided on the left of the rear panel for line output and ground.

Electrically, the BN-6A Amplifier has four separate input channels that can be operated either single ended or balanced. Balanced operation is achieved by means of plug-in transformers. Type 2N175 Low Noise Transistors are used in these input stages and in the following pre-amplifier stage. Following one more amplification stage is the driver, which is a conventional amplifier stage. No phase inversion is needed since a complementary symmetry stage is used in the output. An isolation pad precedes the output transformer. This way both matching and isolation from line impedance variations is achieved very easily. In addition, the pad protects the output transistors from damage in case of shorting the line.

A phone jack is mounted on the front panel for monitoring along with a separate cue switch which provides for amplification of the cue signal received from the studio. This cueing is independent of whether balanced or unbalanced operation is used. The VU meter is used both for monitoring the output level and for battery test. Light weight and long-life mercury batteries are used as a battery power supply for the BN-6A. A separate flash-light

type battery is provided for VU meter illumination. The a-c power supply consists of a full wave rectifier circuit using germanium diodes and an r-c filter.

A weatherproof canvas carrying case is available as optional equipment. The case is so designed that it may be left in place when the amplifier is in use.

**SPECIFICATIONS**

Input Connector.....	Type XL	
Input.....	4 microphones (all may be used simultaneously) 150/30 ohms	
Output.....	Balanced output 600/300/150 ohms plus 18 dbm (5 db isolation provided)	
Gain.....	87 db (150 ohm source on 150 ohm input to 600 ohm load)	
Frequency Response.....	$\pm 1.5$ db from 30-50 cps; $\pm 1$ db from 50-10,000 cps; and $\pm 2.5$ db 10,000-15,000 cps	
Harmonic Distortion (+18 dbm output mixer and master controls set for 65 db gain).....	Less than 1.5% 30-50 cps; less than 1% 50-10,000 cps; less than 2% 10,000-15,000 cps	
Noise Level Referred to Input.....	-122 dbm	
Meters.....	3-inch VU illuminated	
Transistor Complement:		
5-2N175	3-2N109	1-2N35
Dimensions.....	4 1/2" high, 17 3/4" wide, 8" deep	
Weight.....	15 lbs. (approx.)	
Finish.....	Two tone umber gray	
Stock Identification	MI-11221	

**Accessories**

Canvas Carrying Case.....	MI-11377
Input Transformer (30/150 ohms).....	MI-11776
Transistor Kit (for BN-6A).....	MI-11777
Step Type Attenuator for BN-6A Master Controls.....	MI-11751-3
Step Type Attenuator for BN-6A Fader Controls.....	MI-11751-4

**Block Diagram of BN-6A Transistor Portable Remote Amplifier**

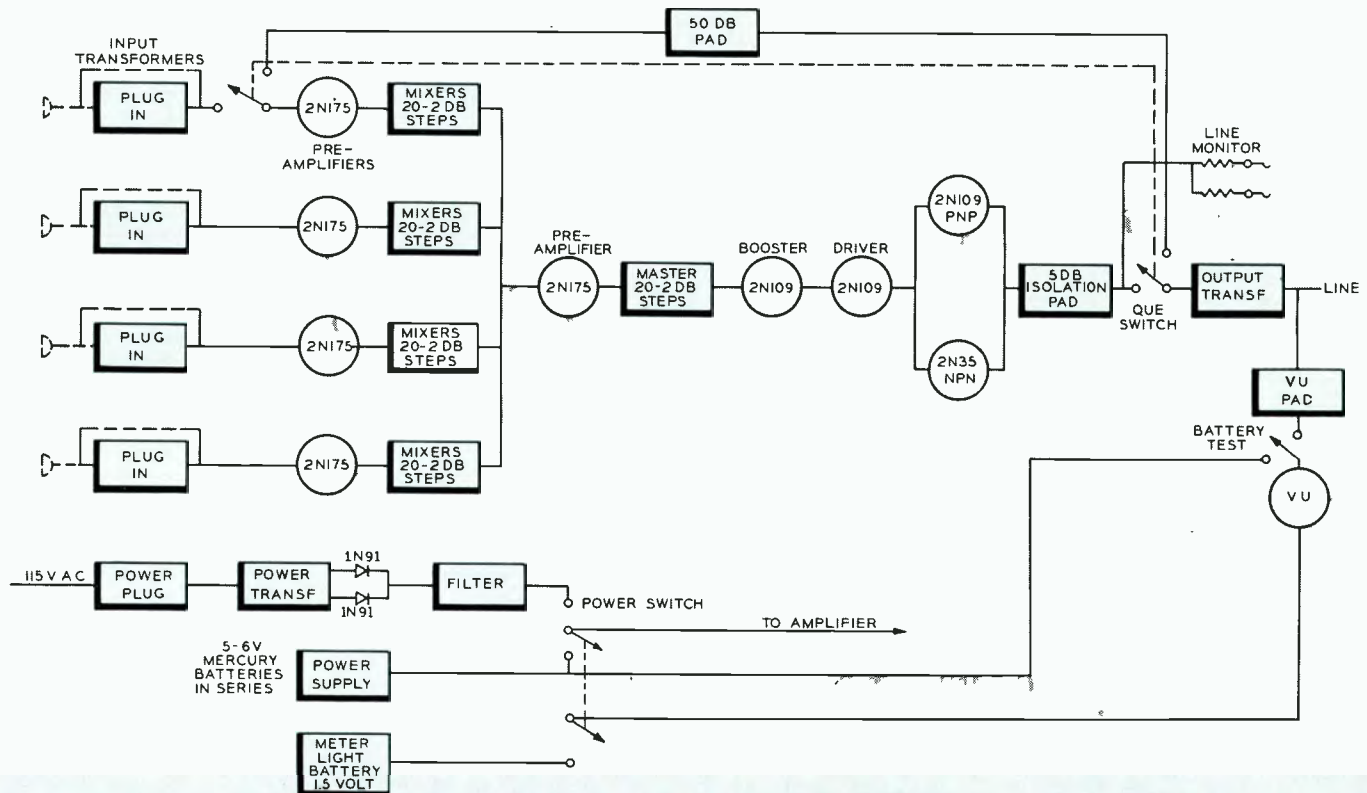



# 10-WATT AMPLIFIER

## TYPE SA-10C

### FEATURES

- Excellent frequency response
- Noiseless mixing between channels
- High gain low noise circuitry
- High impedance inputs
- Microphone input easily converted to low impedance
- Compact, rugged, light weight construction



### DESCRIPTION

The SA-10C Amplifier, MI-12161, has been designed for application in sound systems where a low audio power output is required. It has its own built-in power supply for furnishing a-c and d-c power for the audio tubes.

The RCA MI-12161 is a 10-watt amplifier especially designed to give constant performance and reliability with a wide frequency response at low distortion. The front escutcheon is a reversed etched plate which assures permanent control markings for ease of operation. The bottom cover extends slightly beyond the ends of the chassis. This projection protects the microphone and phonograph receptacles and provides a convenient means of securely mounting the amplifier on a shelf.

High quality microphone receptacle and phonograph jack are provided on the end of the chassis. Auxiliary a-c outlet and screw terminals for audio output connections together with a fuse and the a-c cord are located on the rear of the chassis. A volume control is provided for microphone input and a master control is supplied between the first and second stage. A treble control is provided. The output taps are 4, 8, 16 and 500 ohms (70 volts). The 70 volt or 500 ohm tap is balanced or unbalanced to ground as desired.

The amplifier is designed for either low or high impedance inputs. Should it be desired for low impedance, plug-in transformers are available for either a 50 ohm input or a 200 ohm input. (150 to 300 ohms.)

### SPECIFICATIONS

Power Required.....	117 volts, 50/60 cps, 70 watts
Power Output.....	10 watts at 100 to 5000 cps
Input Impedances:	
Microphone.....	85,000 ohms (minimum) at 1000 cps
Phonograph.....	250,000 ohms (minimum)
Output Impedances.....	4, 8, 16/500 ohms (70 volts)
Gain:	
Microphone Input.....	102 db $\pm 2$ db
Phonograph Input.....	87 db $\pm 2$ db
Frequency Response.....	$\pm 2$ db, 50 to 15,000 cps
Distortion.....	Less than 5.0% to 5000 cps and 10 watts output
Signal to Noise Ratio.....	53 db
Tube Complement (furnished with the unit):	
1—5Y3-GT	2—6V6-GT
1—6SL7-GT	1—6SJ7
Fuse (furnished with the unit).....	Type 3AG, 1 ampere
Dimensions (overall).....	Length 13", Depth 8 $\frac{3}{8}$ ", Height 6 $\frac{3}{4}$ "
Weight, Unpacked.....	11 $\frac{1}{2}$ lbs.
Chassis and Bottom Cover Finish.....	Dull black lacquer
Stock Identification.....	MI-12161

### Accessories

Plug-in 200 Ohm Input Transformer.....	MI-12399
Plug-in 50 Ohm Input Transformer.....	MI-12398

# AMPLIFIER ACCESSORIES

## BRIDGING CONTROLS

### DESCRIPTION

The MI-11278-E and -F Bridging Volume Controls are designed to provide a high resistance bridging input circuit for connections between any low impedance source and the 150/600 ohm input terminals of an amplifier. The use of one of these units makes it possible to pick up program material conveniently from a program buss or any low impedance terminated line without disturbing the operation characteristics of the buss or the line. Any line of +40 dbm or below may be bridged. The MI-11278-F Volume Control is designed to be mounted on the chassis of such amplifiers as the BA-21A and BA-24A. The center shaft of this control is notched for screwdriver adjustment. The MI-11278-E Volume Controls are designed for rear panel mounting on the same type amplifiers. They are supplied with dial knobs which mount on shafts extending through the panel.



MI-11278-F

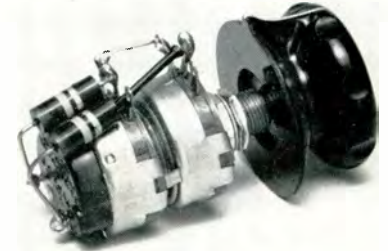

MI-11278-E

### SPECIFICATIONS

Input Impedances .....	20,000/10,000 ohms
Output Impedances.....	600/150 ohms
Insertion Loss*.....	.31/24 db
Maximum Input Level.....	+40 dbm
Overall Dimensions:	
Length:	
MI-11278-E .....	2 <sup>15</sup> / <sub>16</sub> "
MI-11278-F .....	2 <sup>3</sup> / <sub>16</sub> "
Diameter .....	1 <sup>3</sup> / <sub>8</sub> "
Weight .....	4 <sup>1</sup> / <sub>2</sub> ozs.
Stock Identification:	
For Panel Mounting (with knob).....	MI-11278-E
For Chassis Mounting (with screw-driver adjustments).....	MI-11278-F

\* Bridging a 600-ohm line and operating into an amplifier with unloaded input requiring a source impedance equal to the output impedance of the control. The insertion loss when bridging a 150 ohm line is 42.5/36 db.

## VU METER AND ATTENUATORS

### DESCRIPTION

VU meters and attenuators are available as amplifier accessory equipment for indicating audio volume levels. Equipment is pictured at the left and may be ordered as follows:

- Simpson VU Meter.....Stock #53064
- Multiple Pad for calibrating the VU Meter  
to the desired reference level.....Stock #19328
- Zero Adjustment Pad.....Stock #19327

The complete kit is pictured at the left.





# STANDARD CABINET RACKS

## BR-84 SERIES



BR-84A

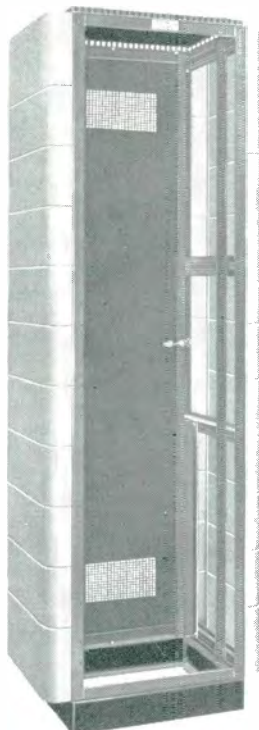

BR-84B

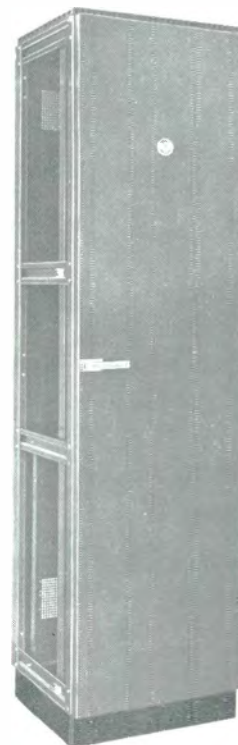

BR-84C

### FEATURES

- Cabinets are same height as RCA transmitters
- Total panel space 77"
- Available in many combinations to suit all studio applications
- Drilled and tapped for standard 19" panels
- Attractively styled to blend with all control room installations
- Suitable for fitting in a flush position to a side or rear wall
- Accommodates the heaviest equipment encountered in studio use
- Provides flexibility for future expansion

### USES

The BR-84 series cabinet rack program is another of the new feature lines of RCA. The cabinet program is presented after years of practical experience in finally developing a flexible scheme for accommodating broadcast equipment.

### DESCRIPTION

The five combinations of cabinets and accessories offer a versatile system for accommodating the user's immediate requirements with maximum accessibility for any future growth of the installation. Each rack may be mounted singly or, where desired, tandem together to facilitate the



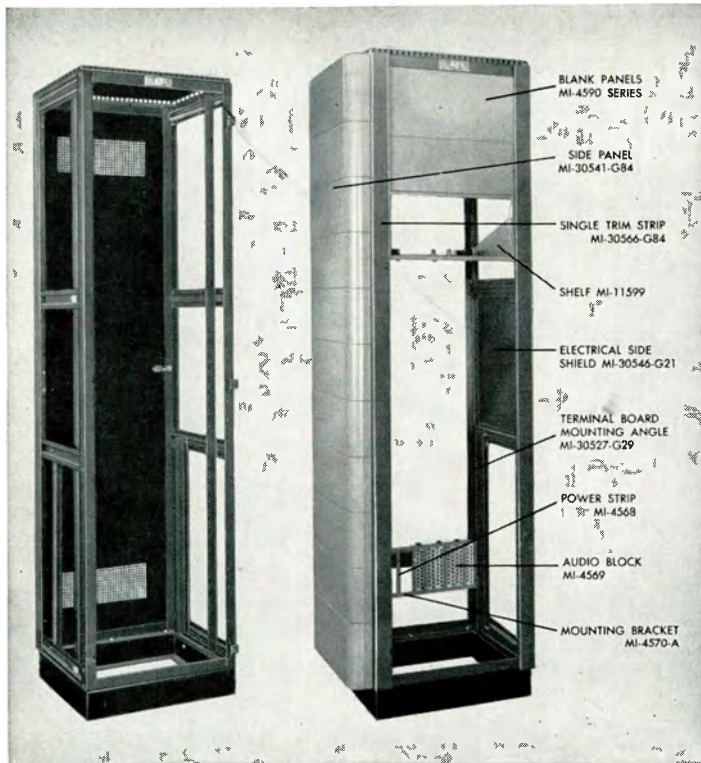

**BR-84D**

**BR-84E with Accessories**

grouping of any number of cabinets. The cabinet is of sturdy metal construction, welded and bolted in one standard height and width. The ventilated top with slotted edges provides complete ventilation but protects the equipment from falling articles and dust. Vertical panel mounting angles have tapped holes at RMA standard locations to provide 77" of standard 19" panel mounting space. These angles may be installed to mount equipment within the cabinet, where doors are used, or flush with the front. When the latter method is desired, trim strips of neat design for panel mounting and clip fitting provide the finished appearance. The front and rear doors are of the universal type and may be hinged on the right or left side, to rotate in an arc of 180°. Electrical side shields are available in two sizes—21" for the center section, and 28" for the top and bottom sections. If found necessary after assembly, they may be fitted between racks of equipment. Terminal board mounting angles facilitate the mounting of power and audio blocks in a vertical or horizontal position. Additional terminal board mounting angles (MI-30527-G29) are available as accessories.

Units placed adjacently may be rigidly bolted together to produce a secure assembly. The cabinets are finished in a two-tone umber gray, with dimensional characteristics artistically blending with all RCA transmitters.

**SPECIFICATIONS**

Panel Width .....	19"
Panel Mounting Space (height).....	77"
Clearance for Door Swing.....	23"
Weight (BR-84A).....	225 lbs.
Finish.....	Two-tone umber gray enamel except for the base which is black
<b>Dimensions:</b>	
Height .....	84"
Width—BR-84-A, -B (with side panels).....	28"
BR-84-C, -D, -E.....	22"
Width of Frame.....	22"
Depth of Frame.....	18"
Depth (including doors and handles).....	24 1/4"

**Stock Identification:**

Type BR-84A consisting of one frame, one base, one top cover, one front door (non-ventilated), one rear door (ventilated), one pair of side panels, one set of terminal board mounting angles and one set of panel mounting angles and instruction book.....	MI-30951-A84
Type BR-84B, same as BR-84A, less front door only.....	MI-30951-B84
Type BR-84C, same as BR-84A, less side panels only.....	MI-30951-C84
Type BR-84D, same as BR-84A, less side panels and front door.....	MI-30951-D84
Type BR-84E, same as BR-84A, less side panels, front and rear doors.....	MI-30951-E84

**Accessories**

One Door (non-ventilated) .....	MI-30530-G84
One Side Panel.....	MI-30541-G84
One Door (ventilated).....	MI-30535-G84
One Electrical Shield (for mid-section of rack) One Per Side.....	MI-30546-G21
One Electrical Shield (for top and bottom sections) Two Per Side.....	MI-30546-G28
*One Single Trim Strip .....	MI-30566-G84
*One Double Trim Strip Used where Two Cabinets Are Placed Together.....	MI-30568-G84
Terminal Board Mounting Bracket.....	MI-4570-A
Blank Panels .....	MI-4590 to 4599 Series
Audio Terminal Block .....	MI-4569
Power Terminal Strip.....	MI-4568
Set Terminal Board Mounting Angles.....	MI-30527-G29
Set Panel Mounting Angles .....	MI-30526-G84
Panel and Shelf Assembly.....	MI-11598-B/11599
Ground Bus Kit.....	MI-11728

\* Trim strips not required if front doors are used.

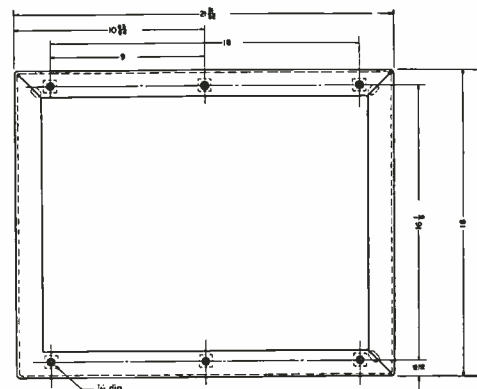

**Layout and dimensions of cabinet base**

# RACK ACCESSORIES

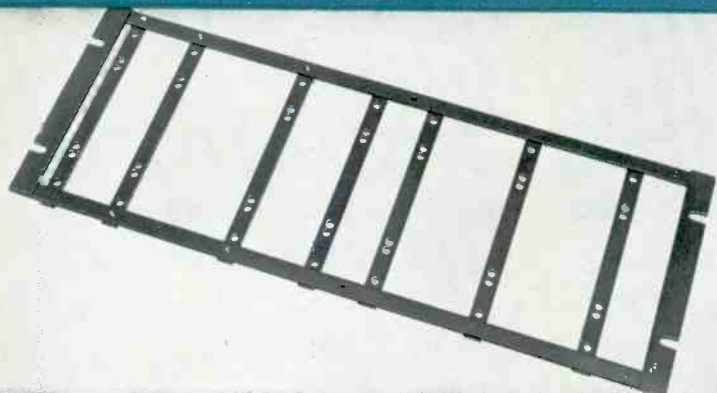

Terminal Block Mounting Bracket MI-4570-A.

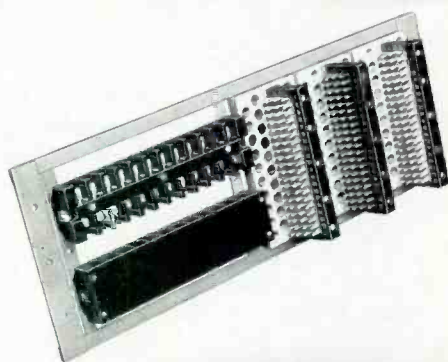

Terminal Block Mounting Bracket MI-4570-A with Terminal Blocks in position.



Power Terminal Block MI-4568.

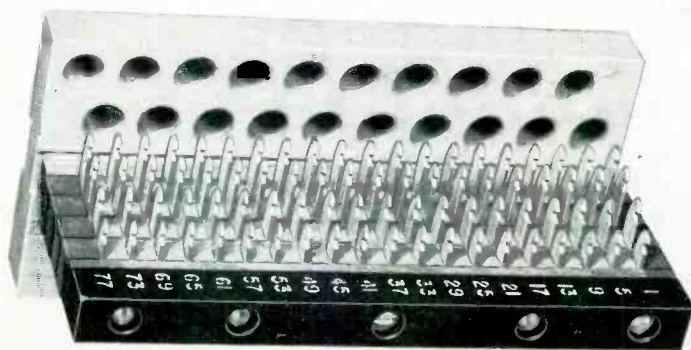

Audio Terminal Block MI-4569.

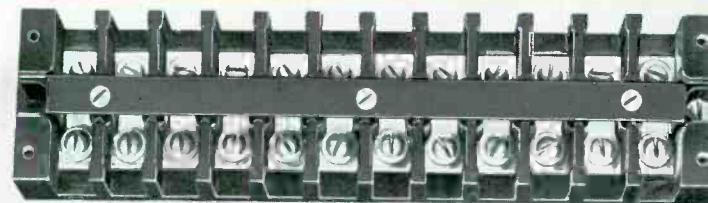

Power Terminal Block MI-4568 with cover removed.



Ground Bus Kit, MI-11728.

## BLANK PANELS

A complete line of 19" blank panels is carried in stock for filling spaces on racks and cabinets not occupied by equipment panels. These blanks are also suitable for applications where equalizers, transformers, switches or other items must be panel mounted by the user. The stock of panels includes all standard widths from 1 3/4" to 10 15/32". They are 3/16" sheet steel and are finished and notched to match standard racks—the BJ-24 and BJ-12.

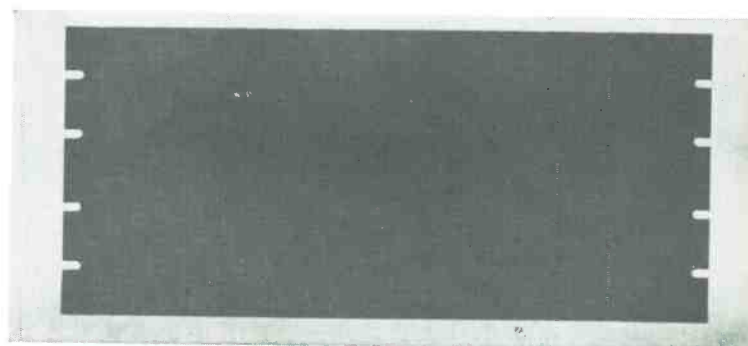

### Panel Width

1	23/32"	Blank Panel, Umber Gray	MI-4590-A
3	15/32"	" " Umber Gray	MI-4591-B
5	7/32"	" " Umber Gray	MI-4592-B
6	31/32"	" " Umber Gray	MI-4593-A
8	23/32"	" " Umber Gray	MI-4594-B
10	15/32"	" " Umber Gray	MI-4595-B



# CABINET RACK

## TYPE BR-19A

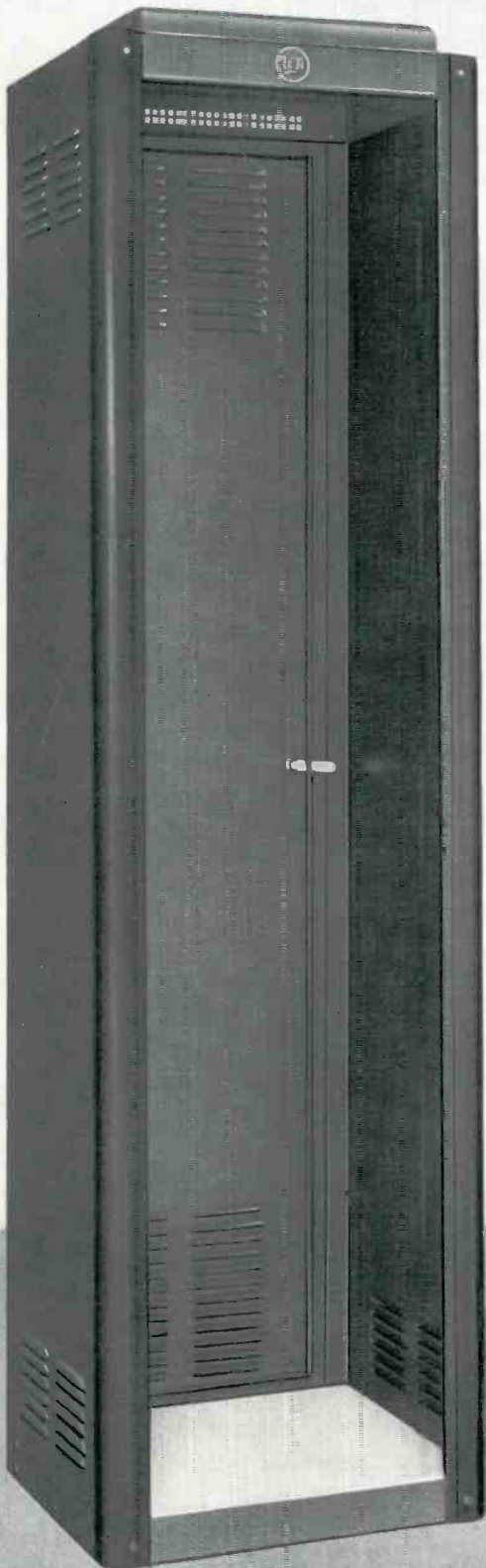

### FEATURES

- Lightweight cabinets designed to blend with all control room installations
- Provides flexibility for future expansion
- Sturdily constructed of  $\frac{1}{16}$ " thick cold-rolled steel
- Drilled and tapped for standard 19" panels
- Modern streamlined styling

### USES

The BR-19A Cabinet has been designed to accommodate broadcast equipment. The cabinets are of lightweight steel construction and offer new cost economies. They provide facilities for mounting standard 19" panels and shelves.

### DESCRIPTION

The BR-19A Cabinet Rack is constructed of  $\frac{1}{16}$ " thick cold-rolled steel. It is provided with rear door only. All racks have quick detachable, new corner trims which are fastened to the front with two studs. This provides for rapid, finger-tip removal without the use of screwdrivers, etc. The cabinets are designed in keeping with modern streamlined styling, and have adequate ventilation through the use of rear, side, and top louvers and vents. Vertical corner mouldings cover the panel mounting screws and all panels fit into a recess so that the edges of panels are not exposed when the corner mouldings are removed.

The panel mountings consist of angle irons of  $\frac{7}{64}$ " thick steel. Holes are accurately drilled and tapped 12-24 thread on universal centers for all types of panels. The BR-19A cabinet is finished in a two-tone umber gray in keeping with other RCA studio equipment.

### SPECIFICATIONS

Panel Width .....	19"
Panel Mounting Space (height).....	77"
Clear Inside Depth.....	16 $\frac{3}{4}$ "
Finish.....	Dark and light umber gray wrinkle
Material.....	$\frac{1}{16}$ " thick cold-rolled steel
Overall Dimensions.....	83 $\frac{1}{2}$ " x 22" x 18"
Weight .....	140 lbs.
Stock Identification .....	MI-11550



# JACK PANELS, MATS AND CORDS



## FEATURES

- Offset ground lugs—easy to wire
- Spacing of jack pairs prevents cross-circuit patching
- Bakelite strip reinforced to prevent warping or breakage

## USES

Jack Panels, with their associated patch cords, are used with broadcast speech input systems to improve the overall operating flexibility. In addition to providing a convenient termination for program and order wire telephone circuits, closed-circuit jacks may be connected to provide "patch cord" access to the input and output circuits of individual units of the speech assembly. When connected for this purpose, the regular circuits are continuous through the jacks until a patch cord is inserted to make an external connection. With properly connected jacks, patch cords may be freely used in emergencies or for test purposes to interchange or transfer telephone lines, amplifiers, mixers, microphones, or other equipment items.

## DESCRIPTION

The BJ-24 consists of two rows of twelve double jacks mounted on thick black bakelite and furnished with designation card holders. The BJ-12 is similar to the BJ-24 but has only one row of twelve double jacks. The jack sleeves of the BJ-24 and BJ-12 are chromium plated.

## SPECIFICATIONS

Number of Jack Pairs		
BJ-24	.....	24
BJ-12	.....	12
Type of Jacks	..... Double jacks of standard closed circuit type	
Dimensions		
BJ-24	..... 2½" x 19"	BJ-12 ..... 1¾" x 19"
Weight (unpacked)		
BJ-24	..... 5½ lbs.	BJ-12 ..... 3 lbs.
Stock Identification		
BJ-24 (RCA Standard)	.....	MI-11645
BJ-12 (RCA Standard)	.....	MI-11646

Photo below shows Convenient Offset Ground Lugs

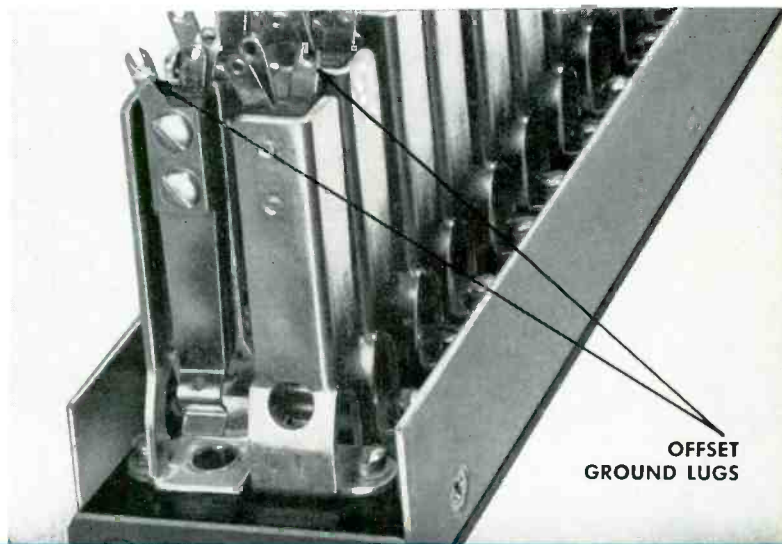

## JACK MATS

Jack Mats are available for covering 1, 2, 3, or 4 type BJ-24 Double Jack Strips.

### SPECIFICATIONS

Single BJ-24 Jack Strip Mat, overall size.....	19" x 3 15/32"
Umber Gray .....	MI-11647-1
Double BJ-24 Jack Strip Mat, overall size.....	19" x 5 7/32"
Umber Gray .....	MI-11647-2

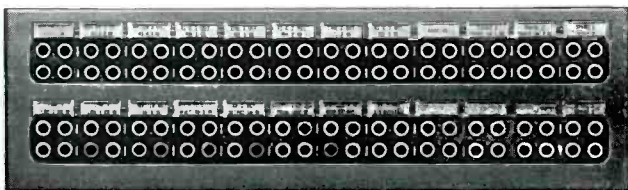

MI-11647-2 Double Jack Mat shown with two double jack strips

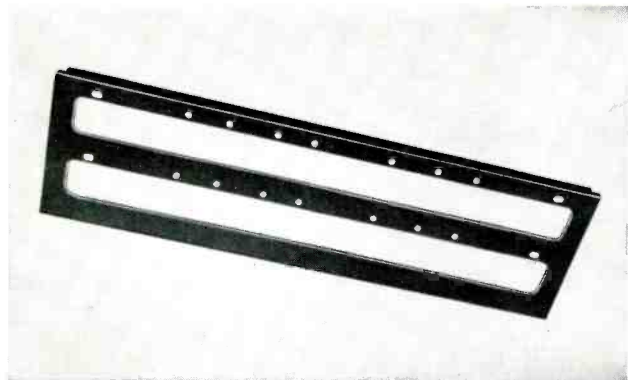

MI-11647-2 Double Jack Mat

View of RCA BR-84 Standard Racks as used at Radio Station WHBQ, Memphis, Tenn. RCA BJ-24 Jack Mats are used in these racks.

## PATCH CORDS

RCA maintains a stock of patch cords for the convenience of broadcasting stations. The W.E. Cord is the standard telephone type using two W.E. 241-A Double Plugs. The Audio Development Co. Cord is shielded and uses two of their Type PJ-1 Plugs which are interchangeable with the W.E. Type 241-A Plug. Three sizes of patch cords are available as listed below:

	Western Electric Co.	Audio Development Co.
Two Foot Cord Length.....	MI-4652-2A	MI-4652-2B
Four Foot Cord Length.....	MI-4652-4A	MI-4652-4B
Six Foot Cord Length.....	MI-4652-6A	MI-4652-6B

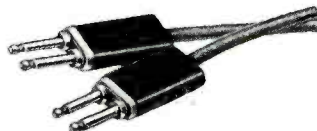

Western Electric Telephone Type Patch Cord



Audio Development Co. Shielded Type Patch Cord

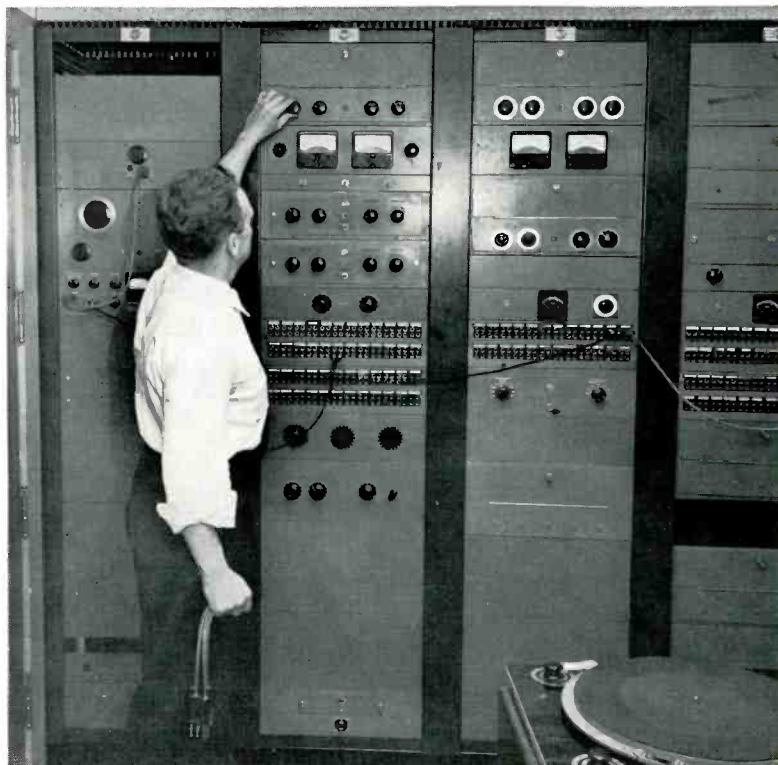



# MOUNTING SHELF

TYPE BR-22A

## FEATURES

- High quality panel mounting for chassis type units
- Quick access to amplifiers and power supplies
- Easy insertion and removal of units
- Hinged front panel
- Conveniently installed from front of rack

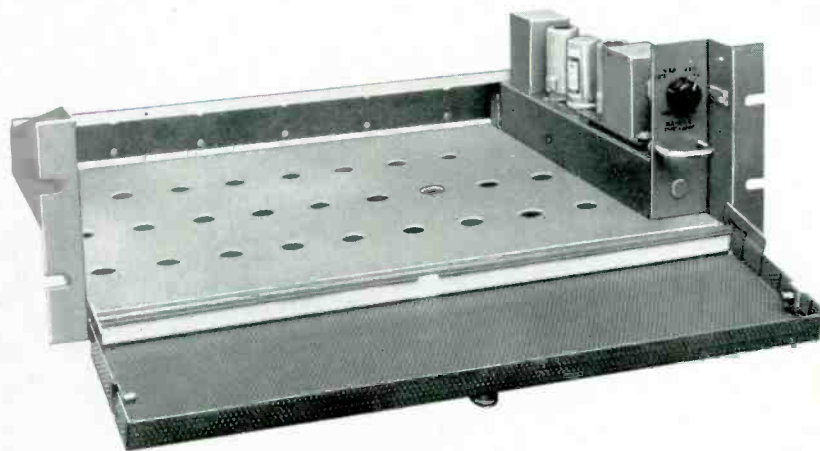

## USES

The BR-22A Mounting Shelf is capable of mounting the following quantities of specific equipments:

- 10 BA-21A Preamplifiers
- 3 BA-23A Program Amplifiers + 1 BA-21A
- 2 BX-21A Power Supplies + 2 BA-21A
- 2 BA-24A Monitor Amplifiers
- 2 BA-25A AGC Program Amplifiers

## DESCRIPTION

This shelf will mount in the BR-84 series of racks, or in any other standard 19" rack. It occupies 5 $\frac{1}{4}$ " of panel space. Since the RCA plug-in amplifiers have a standard dimension in depth, they all fit perfectly in this shelf. They are slipped into the shelf from the front. The receptacles fit in such a manner that a small amount of free movement is permitted in all directions. This eases the alignment of the plugs and receptacles when the amplifiers are pushed into position. The wiring in back of the receptacles is protected by a cover which is fastened in place by two machine screws.

The opening in the front of the shelf is covered by a hinged panel, which may be opened to gain access to the amplifiers and any amplifier controls. The bottom of the shelf has ventilation holes.

A white paper designation strip which is protected by a transparent cellulose acetate strip on the inside bottom flange of the front panel is provided for marking the type number and function of the plug-in unit.

The front panel is perforated to provide additional ventilation. The installations where exposure of the amplifier controls is desired, the front panel may be disassembled from the shelf by removing two screws.

The amplifiers and power supplies are installed on the mounting shelf by means of guide strips and connector receptacles which are included with each amplifier and power supply. The receptacles are assembled to the guide strip which is then attached to the mounting shelf.

## SPECIFICATIONS

Dimensions, Overall:	
Width .....	19"
Height .....	5 $\frac{7}{32}$ "
Depth .....	12 $\frac{1}{2}$ "
Inside Width .....	17 $\frac{1}{8}$ "
Weight, Unpacked.....	10 lbs.
Finish, Front.....	Two tone umber gray
Stock Identification .....	MI-11597



# PANEL AND SHELF

## TYPE BR-2A

### FEATURES

- High quality panel mounting for chassis type units
- Quick access to tubes
- Easy insertion and removal of units
- Provision for control shafts on front panel
- Conveniently installed from front of rack

### USES

The BR-2A Panel and Shelf is capable of mounting the following quantities of specific equipments:

- 6—BA-11A Preamplifiers.
- 2—BA-13A Program Amplifiers.
- 2—BA-12A Booster Amplifiers.
- 2—BX-1E Power Supplies.
- 1—BA-14A Monitor Amplifier plus  
2—BA-11A Preamplifiers.

### DESCRIPTION

This shelf will mount in either the BR-19A or the BR-84 series of racks, or in any other standard 19" rack. It occupies 8 $\frac{3}{4}$ " of panel space. Since the RCA plug-in amplifiers have a standard dimension in depth, they all fit perfectly in this shelf. They are slid into the shelf from the front and the connection plugs pushed into the receptacles at the rear. Guide bars fitting between the amplifiers assist in guiding them into position. All the plug-in amplifiers are equipped with levers which serve either to force them into position or to eject the plugs when dismantling them. The receptacles

Panel removed showing guide bars and receptacles.

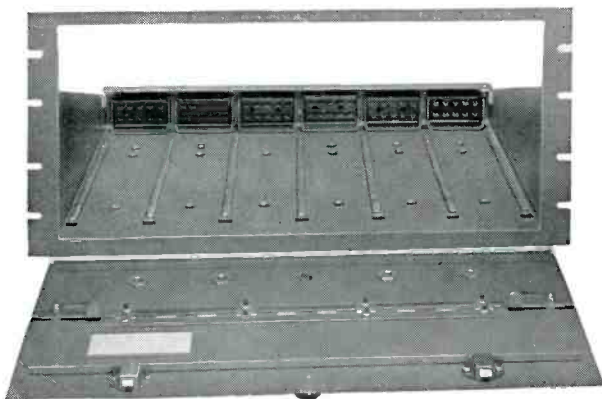

are mounted on individual U-shaped brackets, secured to the chassis of the shelf. They fit in such a manner that a small amount of free movement is permitted in all directions. This eases the alignment of the plugs and receptacles when the amplifiers are pushed into position. The brackets are constructed with a small protruding stop on the lower front edge, preventing the amplifier from being forced to the point where it would exert undue pressure on the receptacle. Provision is made for holding six of these receptacles. The holes in the chassis which are provided for fastening the brackets are slightly oversize to permit perfect alignment during initial installation. The wiring in back of the receptacles is protected by a steel cover which is fastened in place by two machine screws.

The opening in the front of the shelf is covered by a matching panel. This panel is hinged across the center so that the top half may be opened to gain access to the vacuum tubes of the amplifiers. The bottom half has five shaft holes to provide for any controls which the amplifiers may have. When not in use, these holes are covered by small removable buttons. The bottom of the shelf has several round holes for ventilation and also a number of square holes into which fit the amplifier insertion levers.

The shelf may be obtained separately, if desired, or the shelf and panel together, as appropriate. It is supplied complete with mounting brackets, guide bars, and receptacle cover. The receptacles themselves are supplied with the amplifiers, and therefore need not accompany the shelf.

### SPECIFICATIONS

Dimensions, overall:	
Width .....	19"
Height .....	8 $\frac{3}{4}$ "
Depth .....	12 $\frac{3}{4}$ "
Inside Width .....	16 $\frac{7}{8}$ "
Weight, unpacked:	
Shelf .....	12 lbs.
Panel .....	3 lbs.
Stock Identification:	
Shelf (Umber Gray) .....	MI-11599
Panel (Umber Gray) .....	MI-11598-B

**FEATURES**

- Provides meter and switch for measuring cathode voltage of amplifier tubes
- Gives plate current indication of operating condition of tubes and circuits
- Up to 17 circuits may be metered by rotary selector switch



**USES**

The BI-1B Meter Panel provides a convenient means for checking the cathode bias voltages of amplifier tubes and thereby furnishes an indication of the operating conditions of amplifier tubes and circuits. Metering terminals are provided on the miniature series of amplifiers for use with this panel. The mounting is for a BR-84 Series Standard cabinet rack.

**DESCRIPTION**

The BI-1B consists essentially of a meter and switch mounted on a standard 3 1/2", 3/16" thick steel panel. The meter is a 3.0 volt d-c voltmeter having a resistance of

20,000 ohms per volt. The double section switch has eighteen positions including the "off" position with the switch arms connected to the meter terminals. All connections to the panel are made to the switch contacts.

**SPECIFICATIONS**

D-c Voltmeter.....	0-3.0 volts, 20,000 ohm per volt
Metering Switch.....	17 position and "off," double pole
Dimensions (overall):	
Height .....	3 15/32"
Width .....	1 9/16"
Depth .....	2 1/4"
Weight (unpacked) .....	4 1/2 lbs.
Finish.....	Light umber gray
Stock Identification .....	MI-11388

**SWITCH AND FUSE PANEL, Type 57-D**

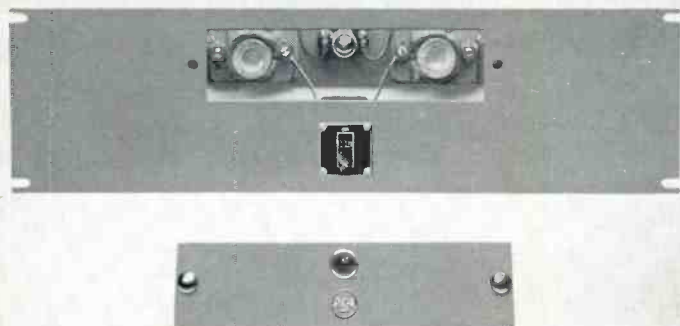

**FEATURES**

- Provides master switch and fuses for rack-mounted equipment
- Pilot lamp glows when equipment is on
- Removable door permits front panel access to fuses and pilot lamp

## 57-D Panel, (cont'd)

### USES

The Type 57-D Switch and Fuse Panel is designed for use as a master input control of the a-c power supply. Ordinarily one such panel is used with each rack or channel of speech input units. The mounting is for a BR-84 Series Standard cabinet rack.

### DESCRIPTION

On this panel are mounted and wired an indicator lamp with red cap, two single fuse blocks of the screw-plug type and a double-pole single-throw power switch. A re-

movable door permits front panel access to fuses and pilot lamp.

### SPECIFICATIONS

Switch.....	D.P.S.T., 250 volts, 30 amperes
Fuses (not furnished).....	Screw-plug type (rating depends upon equipment to be protected)
Dimensions, overall (panel thickness $\frac{3}{16}$ " ):	
Height .....	5 7/32"
Width .....	19"
Depth .....	3 1/2"
Weight (unpacked).....	8 1/2 lbs.
Stock Identification:	
Light Umber Gray.....	MI-4395-G

## VU METER PANEL, Type BI-5A

### FEATURES

- Measures audio volume levels from +4 to +40 vu
- Ten point selector connects up to 10 circuits
- Calibration curve supplied for loads other than 600 ohms
- Large illuminated VU meter

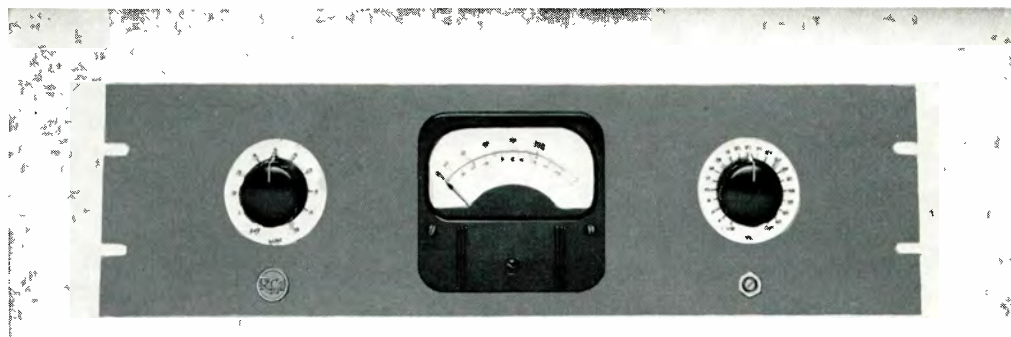

### USES

The BI-5A Meter Panel employs the industry standardized VU Meter which embodies closely controlled electrical and dynamic characteristics combined with deliberate pointer action, moderate pointer speed, and small pointer overswing. It is intended as an audio level indicator for broadcasting, recording or wherever it is desired to read the level of one or more audio circuits with a rack mounting type of instrument.

### DESCRIPTION

The volume indicator panel assembly includes the VU meter, a two circuit ten point selector switch, a variable step-by-step attenuator (4 to 40 db attenuation), and a vernier control for making a fine adjustment of the level reading over a range of  $\pm 0.5$  db. The attenuator has a 1 milliwatt reference position which enables a level reading of zero VU.

The VU meter scale is arranged with percent volts in black figures from "0" to "100" as the principal scale above the arc, and "vu" levels from "-20" to "0" to "+3" as supplementary figures in red below the arc.

The meter and attenuator are calibrated for use with a 600 ohm line, however, a calibration correction curve furnished with the instrument permits its use with loads other than 600 ohms. The ten point selector switch may be connected to any ten lines (or circuits). If one or more switch positions are connected to a jack strip, the number of circuits that may be monitored is unlimited. The meter is provided with the 6.3 volt lamp for illuminating the meter scale.

### SPECIFICATIONS

Input Impedance (except on 1 milliwatt step).....	7500 ohms
Attenuator Steps.....	1 milliwatt position, +4 to +40 db in 2 db steps and off position
No. of lines that may be measured.....	1 to 10 inclusive
Mounting.....	Standard Cabinet Rack
Dimensions:	
Height .....	5 1/4"
Width .....	19"
Depth .....	3 3/4"
Finish.....	Light umber gray
Weight (unpacked).....	7 1/2 lbs.
Stock Identification .....	MI-11265-F



# VARIABLE SOUND EFFECTS FILTER, TYPE BE-21B

## FEATURES

- Permits control of audio bandwidth to produce a variety of sound effects
- Two front panel selector switches permit easy and quick change to desired sound effect

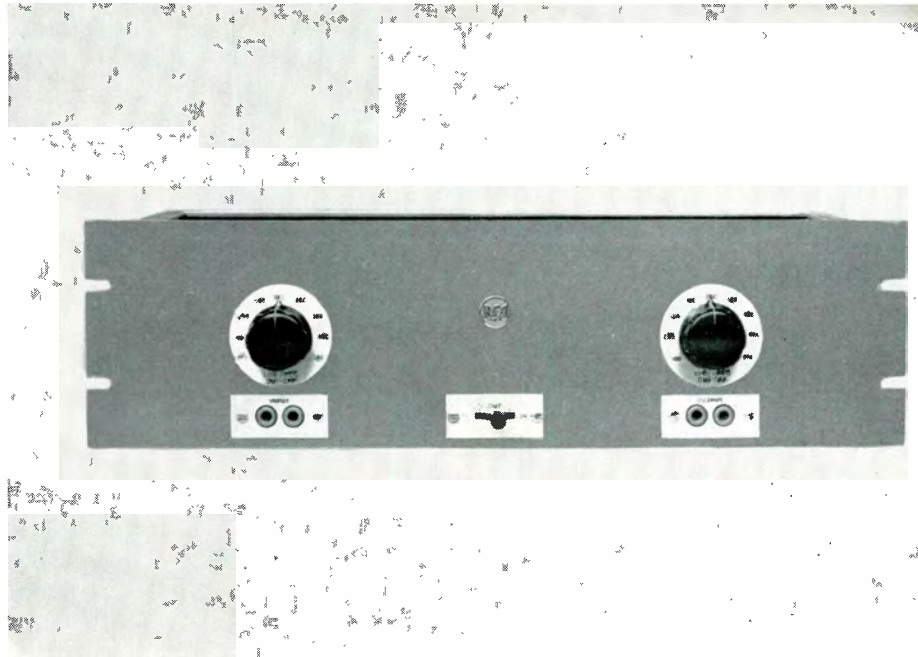

## USES

The BE-21B furnishes a desirable means for producing a variety of special or unusual sound effects through control of the audio bandwidth of the transmitted program. It is especially useful in the production of dramatic plays for making programs sound "bassy" or "tinny" or for simulating the sound of telephone conversations, short wave radio communications or midget radios.

## DESCRIPTION

The BE-21B consists of high and low pass filters assembled on a panel with two selector panel switches. The switches have nine positions each and are calibrated for high and low cut-off frequencies of 100, 250, 500, 1000, 2000, 3000, 4000, and 5000 cycles. There is also an "off" position on each switch. A key switch is provided for removing the filter from the circuit thus making it possible to preset the filter for the desired characteristics and insert it in the circuit instantly when required.

The 600 ohm input and output impedances of the filter enables it to be connected in any 600 ohm circuit or it may be used in a 250 ohm circuit with only a slight change in response characteristics.

## SPECIFICATIONS

Source Impedance (unbalanced).....	600 ohms
Load Impedance .....	600 ohms
Input Level.....	-60 to +23 db*
Output Level (maximum) .....	+23 db*
Frequency Response.....	See curves
Insertion Loss.....	1 db or less at frequencies remote from cut-off
Dimensions, overall	
Height .....	5 1/4"
Width .....	19"
Depth .....	5"
Weight (unpacked).....	15 lbs.
Finish.....	Light umber gray
Stock Identification .....	MI-11723

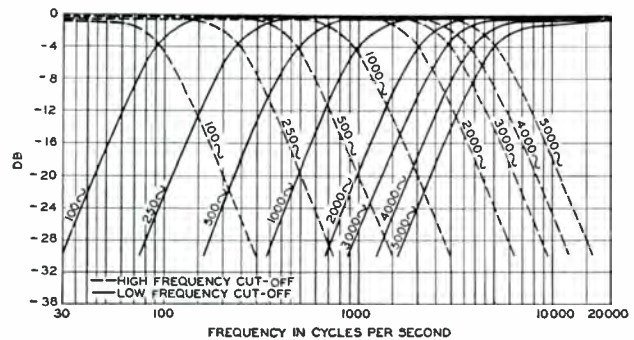

# LINE EQUALIZER

## TYPE BE-2A

### FEATURES

- Provides line equalization to 15,000 cycles
- Equalization variable in steps of 3 db
- Small case mounts almost anywhere
- Parallel resonant circuits
- Convenient rotary selector switch for selecting different resistance values

adjustment of the equalizer consists of an audio-frequency oscillator such as the RCA Type WA-28A for use at the remote point, and a volume-indicator meter such as the WM-71A for use at the receiving point.

### USES

The RCA Type BE-2A Line Equalizer is designed to equalize the non-linear frequency characteristics of a non-loaded telephone line. It is suitable for 15,000 cycle FM circuits. The small, low-cost unit is recommended for use on lines which are permanently installed and continuously used such as studio-to-transmitter lines and remote lines.

### DESCRIPTION

The BE-2A Line Equalizer employs parallel resonant circuits and consists of a capacitor, a reactor, a series of resistors, and a rotary selector switch for selecting different resistance values. The resonant frequency of this circuit is just above the operating frequencies of associated equipment, so that the frequency characteristics of the equalizer below resonance are of interest. Examination of these characteristics (shown in the chart) reveals that the more resistance in series with inductor, the less the low-frequency attenuation of the equalizer. Any of the amounts of equalization shown by the frequency characteristics chart may be obtained by rotating the ten position selector switch to the proper dial setting, thereby inserting the desired resistance in the circuit. Varying amounts of equalization may be obtained in steps of approximately 3 db. The BE-2A does not include line transformers or master attenuators which should be ordered separately where required.

The equalizer circuit is housed in a cadmium plated metal case adaptable for mounting on a flat surface. It is especially recommended for mounting on a 3 1/2" x 19" panel for standard rack mounting. The equipment necessary for

### SPECIFICATIONS

Source Impedance .....	150 or 600 ohms
Equalization Frequency Limit .....	15,000 cycles
Insertion Loss (minimum at 1000 cycles).....	.7 db
Equalization Range (see attenuation characteristic curve) .....	1 to 40 db
Mounting .....	Single hole
Dimensions .....	2 7/8" wide, 2 1/2" high, 3 3/8" deep
Weight .....	1 1/4 lbs.
Finish .....	Cadmium plate
Stock Identification .....	MI-11752

### Accessories

Mounting Panel 3 1/2" x 19" .....	MI-4591-B
Line Transformer .....	MI-11713

Frequency characteristic of Type BE-2A Line Equalizer.

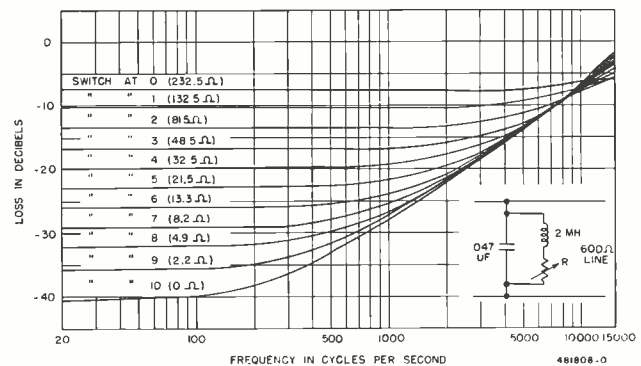



# LINE AND BRIDGING TRANSFORMERS

## DESCRIPTION

The following standard RCA transformers are stocked as a convenience to broadcasting stations. These transformers are of the highest quality design having excellent frequency response. They are provided with electrostatic shields between primary and secondary and are furnished with heavily shielded cases. Cores are of special high permeability steel. Terminals are at one end and diagrams of the connections are stenciled on the side of the case. Broadcasting stations may employ the RCA transformers between units with assurance that the overall fidelity of the system will be maintained.

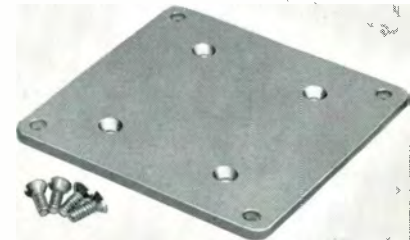
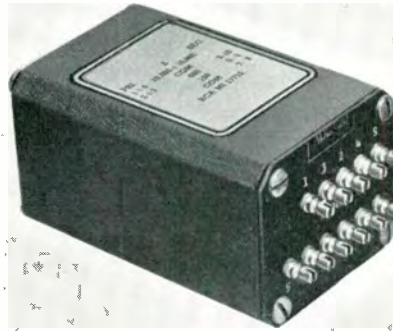

### LINE TRANSFORMER, MI-11713

The core structure, frequency characteristics and shielding of this transformer makes it an ideal unit for isolating line circuits. Its taps provide several combinations of available impedances. One to two of these transformers are very useful items to have around any broadcast station.

#### Specifications (MI-11713)

Frequency Response..... $\pm 1/2$  db 20 to 20,000 cps

Primary Impedances	Secondary Impedances
Ohms	Ohms
150	150
600	600

Stock Identification .....MI-11713

### BRIDGING TRANSFORMER, MI-11712

This transformer may be used as an input transformer for a bridging line amplifier or a monitoring amplifier. It may also be satisfactorily used where it is desired to bridge a program line to feed programs to other mixing or outgoing circuits such as normally employed in a master control room line distribution system.

#### Specifications (MI-11712)

Frequency Response..... $\pm 1/2$  db 20 to 20,000 cps.

Primary Impedances	Secondary Impedances
Ohms	Ohms
20,000	150
	600

Stock Identification .....MI-11712

## GENERAL SPECIFICATIONS for MI-11713 and MI-11712

Dimensions, overall:

Transformer..... 4" x 2 11/32" x 1 7/8"  
 Baseplate..... 3 1/4" x 3 1/4"

Mounting.....Four holes with center lines 2 3/4" x 2 3/4"

Weight.....2 lbs. 14 ozs.

Finish .....Aluminum gray



## DESCRIPTION

RCA offers a comprehensive selection of attenuator pads, bridging pads and dividing networks. The pads and networks are well constructed and insulated with precision wound resistors, assuring no internal reflection. The terminals are accessible and securely mounted with the connections stenciled in an appropriate place. The fixed balanced "H" type is available in two types, one introducing a loss of 6 db, the other 10 db. The dividing networks are also available in two types, unbalanced and balanced "H" type, as tabulated below.

### Fixed Pads—Balanced "H" Type

Input Impedance.....	600 ohms
Output Impedance.....	600 ohms
Insertion Loss.....	6 db
Stock Identification .....	MI-4171-29

### Fixed Pads—Balanced "H" Type

Input Impedance.....	600 ohms
Output Impedance.....	600 ohms
Insertion Loss.....	10 db
Stock Identification .....	MI-4171-30



MI-11704-A

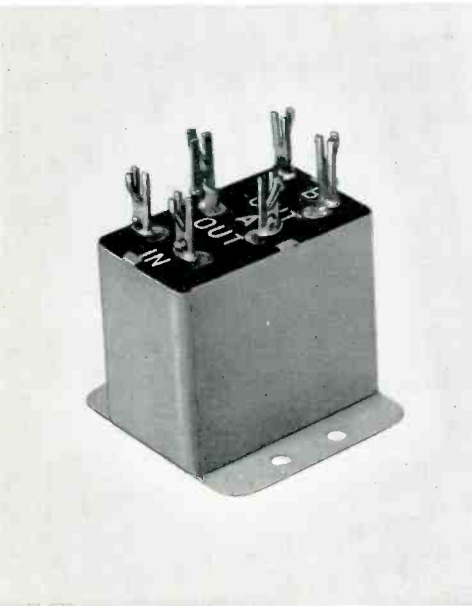

MI-4171-29 ►

◀ MI-11705

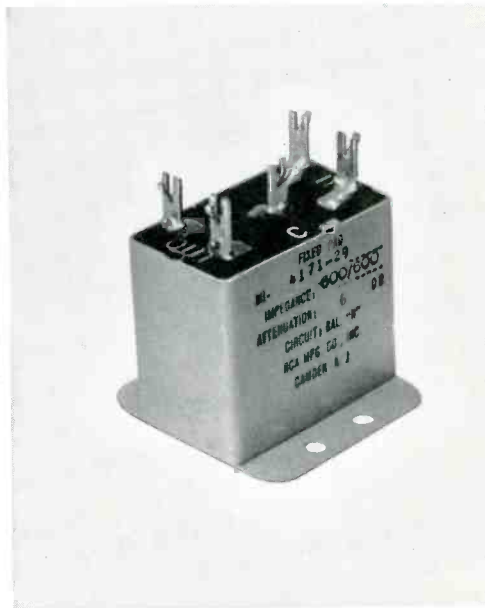

## Dividing Networks

Balanced Two-way, 600 ohms

Insertion Loss.....	6 db
Stock Identification .....	MI-11704

Balanced Three-way, 600 ohms

Insertion Loss.....	9.5 db
Stock Identification .....	MI-11704-A

Balanced Four-way, 600 ohms

Insertion Loss.....	12 db
Stock Identification .....	MI-11704-B

Balanced Six-way, 600 ohms

Insertion Loss.....	15.6 db
Stock Identification .....	MI-11704-D

## Bridge Pad (Balanced)

Input Impedance..... 600 ohms to two 600 ohm lines— isolation between lines about 45 db

Insertion Loss.....	10 db
Stock Identification .....	MI-11705

# REGULATED POWER SUPPLY

MI-11316

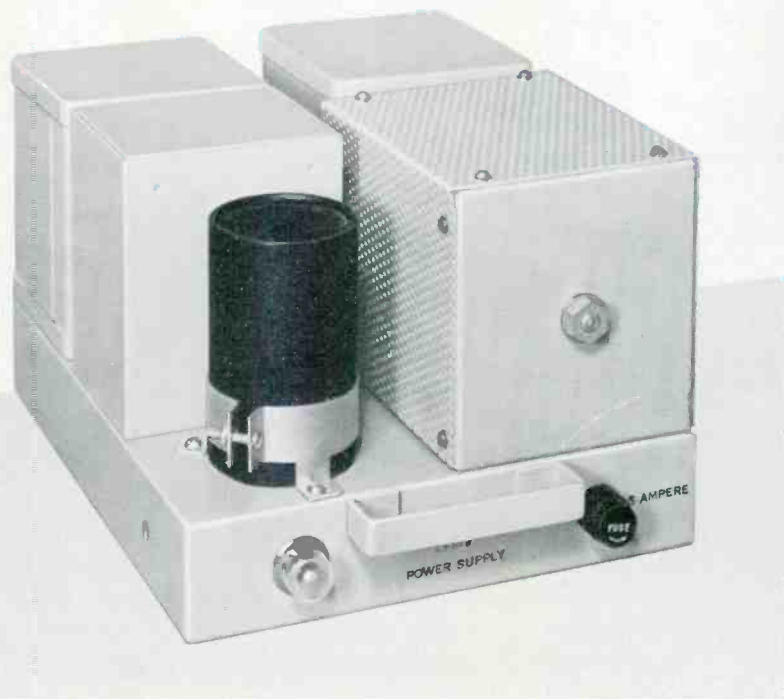

## DESCRIPTION

The MI-11316 is a selenium rectifier type power supply. It provides 3 amperes maximum 24 volts d-c, operating from a nominal 117 volts 50/60 cps source. This power supply is recommended for use with the TC-4A Basic Buy TV relay switching equipment. It is also required to operate the BCS-11A Master Switching Console.

This power supply may be mounted on a standard RCA Panel and Shelf, BR-2A.

## SPECIFICATIONS

Input.....110-125 volts 50/60 cps 200 V.A. or 125 watts  
 Output.....3 amperes, 24 volts d-c  
 Regulation.....Better than 5% voltage regulation, no load to full load  
 Ripple.....60 and 120 cycle components, less than 3% at full load

Size.....Length 9", Width 7 $\frac{3}{4}$ ", Height 5 $\frac{3}{4}$ "  
 Weight .....25 lbs.  
 Shipping Weight.....Approximately 30 lbs.  
 Finish.....Light gray baked enamel over zinc chromate primer on 16 gauge steel  
 Stock Identification .....MI-11316

MI-11316 POWER SUPPLY SCHEMATIC DIAGRAM

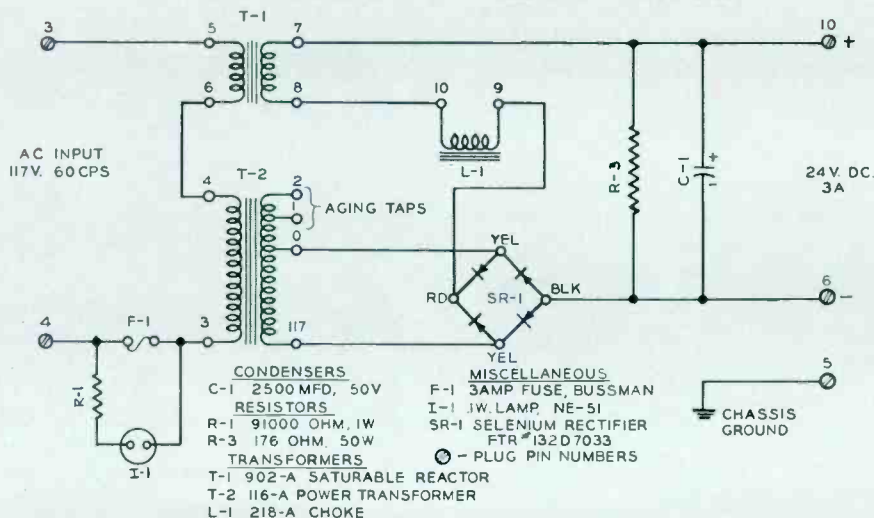

# STUDIO WARNING LIGHTS

MI-11706 SERIES



## FEATURES

- Modern styling
- Satin chrome finish
- Available in five types
- Uniform illumination
- Easily mounted

## USES

The MI-11706 series of warning lights is another new product to supplement the RCA line of modernistically designed studio equipment. These lights have been developed after many requests from broadcasters to furnish a studio warning light that has bold and uniformly illuminated lettering with an external design that would enhance the appearance of any studio.

## DESCRIPTION

The lights are constructed of satin finish cast aluminum with trimmed etchings and tastefully styled for all studio furnishings. The sign is an opaque black glass with frosted translucent 2" letters, using a 40 watt 12" lumiline lamp for a light source.

The interior or mounting base, containing the lamp, sockets and terminal strip for the a-c supply, is of separate metal

construction and insures adequate protection from wires short-circuiting. The complete interior is a wall mounting fixture and allows a new lamp to be replaced quickly by simply removing the outer case by two screws. The warning light is available with five signs as indicated below.

## SPECIFICATIONS

Dimensions: (overall of case)	
Length .....	14"
Width .....	3 1/2"
Depth .....	2 1/16"
(Glass Sign Aperture)	
Length .....	9 3/4"
Width .....	2 3/4"
Weight (unpacked) .....	3 1/2 lbs.
Stock Identification:	
"ON-AIR" .....	MI-11706-1
"REHEARSAL" .....	MI-11706-2
"AUDITION" .....	MI-11706-3
"STANDBY" .....	MI-11706-4
"SILENCE" .....	MI-11706-5
Glass Only .....	MI-11718-1 to 5



Back view showing simplicity of construction and outer case mounting screws



Outer case removed showing Lumiline illuminating lamp



# THREE-SPEED TURNTABLE

TYPE BQ-2B

## FEATURES

- Simplified speed changing mechanism for ease of operation and reduced maintenance
- Reliable, hysteresis synchronous motor
- Provides a high-quality driving mechanism for 33 $\frac{1}{3}$ , 45 or 78 rpm records
- Rugged and simple construction—less parts to wear
- Very smooth starts—necessary with microgroove
- Rugged drive assembly and resonance-free wooden cabinet built to give many years of satisfactory service
- Superior performance at moderate cost



## USES

The RCA type BQ-2B Transcription Turntable meets broadcasting needs for a high-quality driving mechanism which will accommodate all types of commercial disc recordings up to 16" in diameter at speeds of 33 $\frac{1}{3}$ , 45 or 78 rpm. The drive assembly is extremely reliable and quiet, and meets all NARTB performance specifications, assuring fidelity in the reproduction of broadcast transcriptions. The cabinet assembly not only provides a simplified mounting for the drive assembly, turntable and operating

controls, but allows ample room for housing the reproduction equipment. All standard types of broadcast tone arm equipment may easily be mounted on the cabinet and, if desired, two tone arms for various types of pickups can be accommodated. The cabinet has a spacious compartment where equalizer equipment and necessary amplifiers may be installed.

The BQ-2B Drive Mechanism is available as a separate unit for those stations which may wish to mount it in a custom built cabinet, bench, or table.

**RUGGED CONSTRUCTION**—Sturdy 16-inch turntable platter with large spindle accurately machined to give many years of service.

**QUIET OPERATION**—Cushion-mounted motor operated by silent mercury switch.

**ACCURATE PERFORMANCE**—Large sleeve bearing provides accurate turntable alignment.

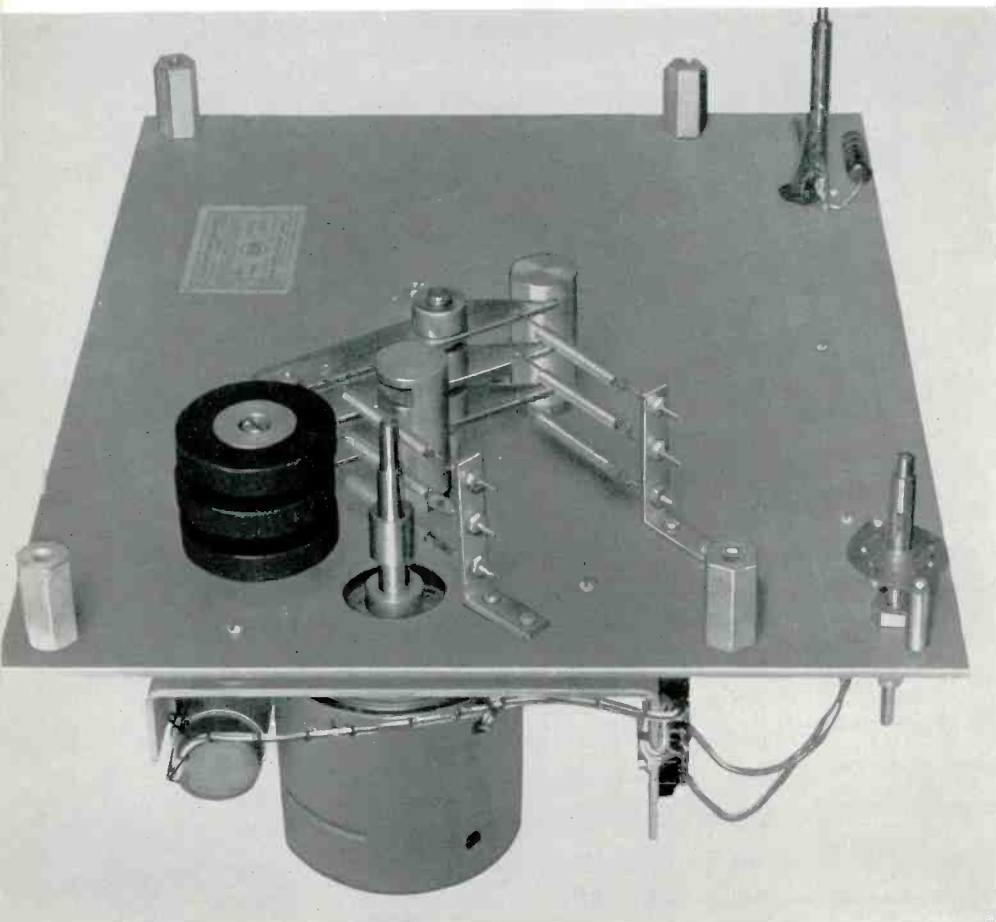
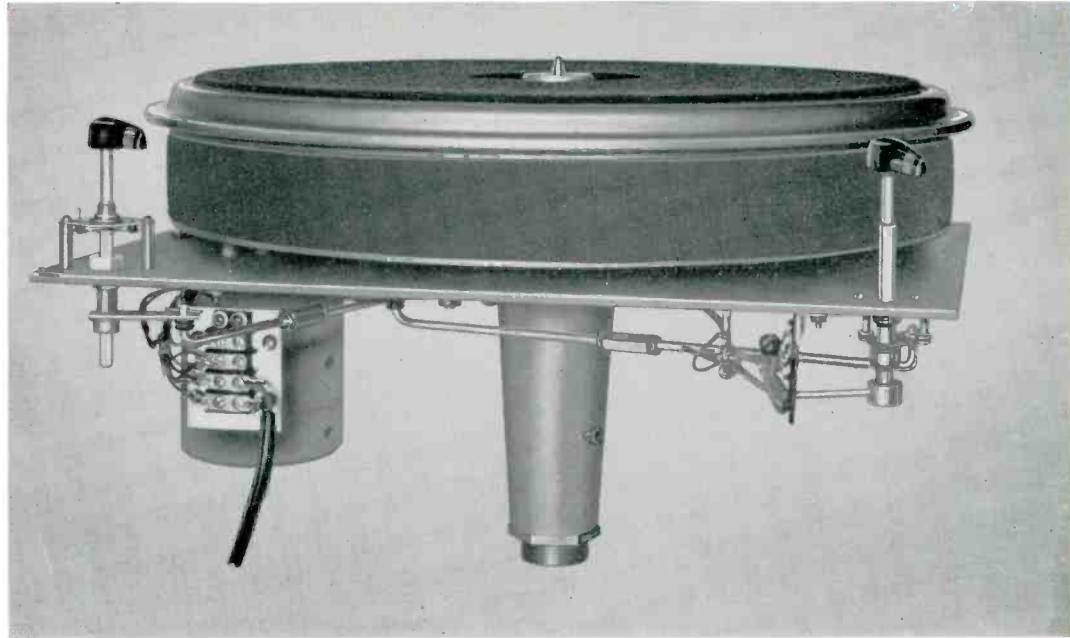

**FAST CUEING**—Reliable hysteresis synchronous motor provides ample driving power and quick smooth starts.

**GOOD DESIGN**—Simplified speed changing mechanism has minimum of moving parts, self-compensating neoprene idlers.

**LONG LIFE**—"Off-On" switch relieves idlers in "Off" position providing extended puck life—one of many long-life features.

**ACCURACY**—Separate speed selector and "Off-On" switches for positive on-speed starting.

**EASE OF OPERATION**—Quick speed change with or without turntable revolving; snap-up spindle for 45 rpm operation assures ease of record handling and proper centering.

## DESCRIPTION

The BQ-2B Turntable Drive Assembly is a three-speed, rim-drive type mechanism consisting of a hysteresis synchronous motor with a three-step diameter pulley coupled directly to the motor shaft. The speed of the turntable is determined by the ratio of diameters between the motor pulley and the turntable rim. Two models are provided, one for operation with 60 cycle power supply (MI-11830-B), and another for 50 cycle use (MI-11831-B). The only difference between the models is in the respective diameters of the three-step motor pulley since the motor with its capacitor is designed for both 60 and 50 cycle operation.

A cabinet of modern design is provided to house the turntable equipment. This wooden console has a durable two-tone, umber gray fabrikoid covering which is resistant to scuff and scratches, and will not chip like enamel or

lacquer surfaced cabinets. A cigarette-proof linoleum top with aluminum trim is provided. A large hinged door is located on the front of the cabinet to permit ready access to the interior. When desired, this door may be completely removed from its hinges. Ample interior space is available for mounting reproduction filters and booster amplifiers such as the RCA type BA-12A. The a-c power cord is brought through the bottom of the cabinet and connected to the motor terminal board.

A three-position speed selector switch is linked to a cam which allows the three rubber idlers to engage, one at a time, between the motor pulley and the turntable rim. An "Off-On" selector knob operates a mercury switch which energizes the motor and simultaneously engages or disengages the rubber idlers in the "On" or "Off" positions respectively.

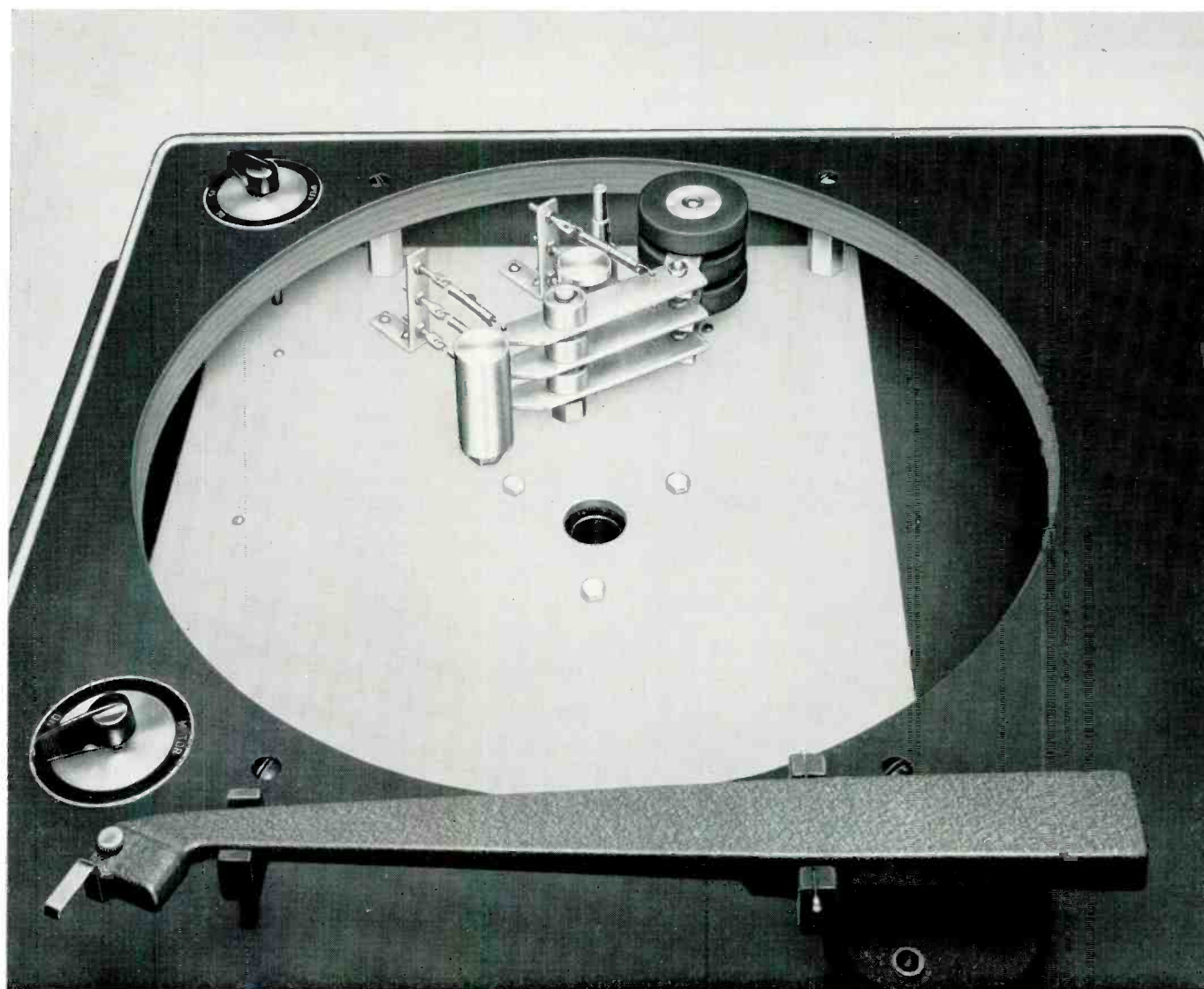



The turntable platter is a sturdy 14-pound aluminum casting. It and the spindle assembly are held in the main support casting in oilite bushings and the thrust is supported by a single ball at the bottom end of the spindle. A belt of foam rubber is affixed to the outside rim of the platter in order to eliminate any resonance effects. The drive motor is mounted on a separate plate and supported by vibration mounts to eliminate rumble. All posts and shafts which provide bearings for cams and arms are assembled to a common plate to insure proper alignment.

A feature of the motor drive assembly is the use of a separate speed control which can be adjusted without motor stopping between any combination of speeds. A separate starting switch is provided to handle cueing and routine operation in the most functional manner. This "On-Off" switch relieves the neoprene idlers when set to the "Off" position, thus providing extended puck life.

The BQ-2B Transcription Turntables are supplied less tone arms and filters. These are supplied as accessories and should be selected according to the type and variety of recordings to be played. A template is supplied with the Instruction Book and should be used as a guide in mounting controls, tone arms and filters on the RCA cabinet, or any other suitable cabinet, table or bench.

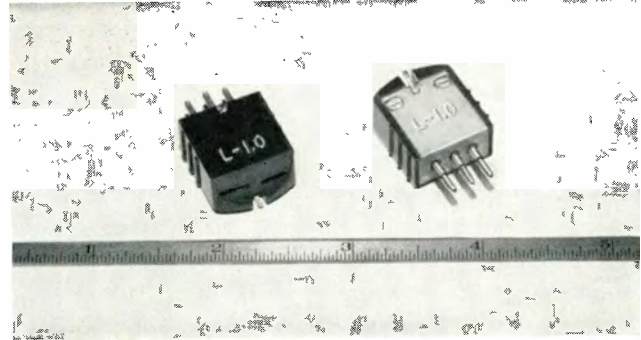

Plug-in Type Pickup Head, MI-11874-4, used with BQ-2B.

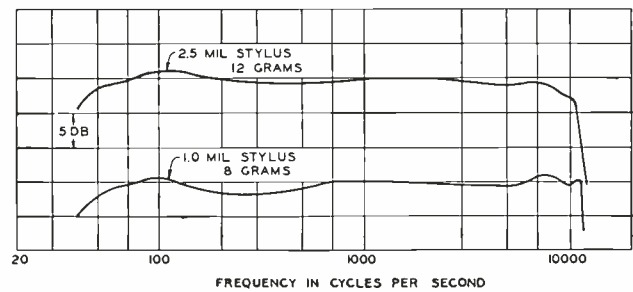

Typical response of Pickup, Tone Arm and Filter.

**SPECIFICATIONS**

**Performance Specifications**

- Turntable Speed..... 33⅓, 45 and 78.26 ±0.3%
- Wow or Flutter:
  - At 33⅓ rpm.....0.25% half of peak of peak
  - At 45 rpm.....0.20% half of peak of peak
  - At 78 rpm.....0.20% half of peak of peak
- Motor.....1/100 H.P., 1800 rpm at 60 cycles, or 1/125 H.P., 1500 rpm at 50 cycles, 45° C. temperature rise, 2 or 3 mf 220 working volts capacitor.
- Power Supply.....105-125 volts, 50/60 cycles, single phase
- Power Consumption.....40 watts
- Turntable Diameter .....16"
- Hub and Spindle Diameter:
  - Hub for 45 rpm Records.....1.5"
  - Spindle for 33⅓ and 78 rpm.....0.2835"
- Overall Dimensions:
  - Turntable Drive Unit.....18" long, 18" wide, 11" high
  - Cabinet.....23½" wide, 24¾" deep, 28" high (adjustable ¾")
- Weight:
  - Turntable Drive Unit.....31 lbs
  - Cabinet ..... 60 lbs.
  - Total Weight .....91 lbs.
- Finish.....Two tone umber gray fabrikoid with aluminum trim

**Equipment Supplied**

- BQ-2B Turntable and Cabinet including turntable drive assembly, console cabinet, turntable platter assembly and Instruction Book (IB-24780), but less reproducing equipment such as tone arms and amplifiers:
  - For 60 cycle operation.....MI-11833-B
  - For 50 cycle operation.....MI-11834-B
- BQ-2B Turntable Drive Assembly, less console cabinet and reproducing equipment such as tone arms and amplifiers:
  - For 60 cycle operation.....MI-11830-B
  - For 50 cycle operation.....MI-11831-B

**Accessory Equipment**

- Lightweight Tone Arm (Less Pickup Head).....MI-11885-A
- 1.0 Mil Fine Groove Diamond Stylus Pickup (for Lightweight Tone Arms).....MI-11874-4
- 2.5 Mil Standard Groove Diamond Stylus Pickup (for Lightweight Tone Arms).....MI-11874-5
- Pickup Filter for Lightweight Tone Arms.....MI-11888
- BA-12A Booster Amplifier.....MI-11232
- BN-5A Booster Amplifier.....MI-11249
- BA-24A Monitoring Amplifier .....MI-11247

# LIGHTWEIGHT TONE ARM

MI-11885-A

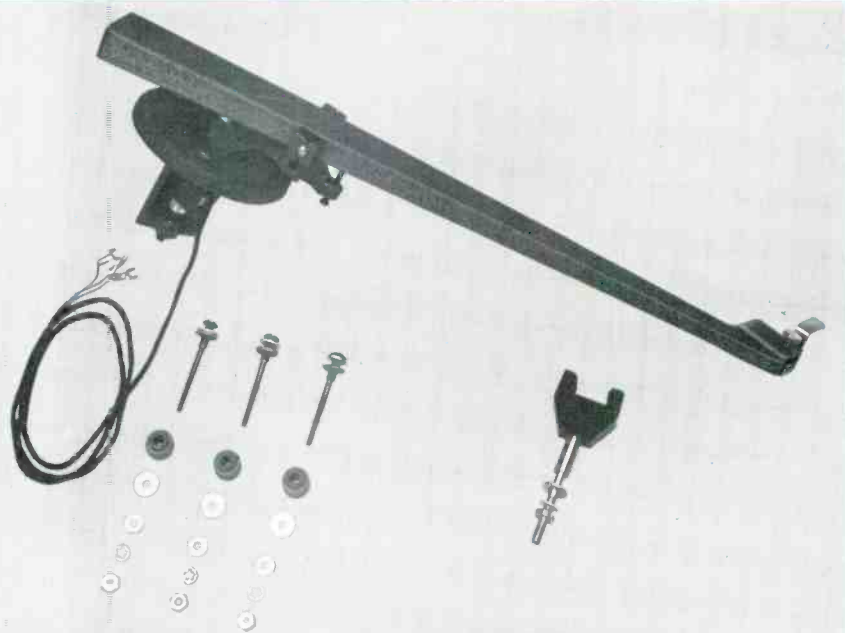

## FEATURES

- Used with RCA plug-in heads, provides high quality reproduction of 45 rpm and 33 $\frac{1}{3}$  rpm fine groove records, standard transcriptions and commercial records
- May be applied to existing turntables.
- Less than 4 degrees tracking error on any standard record
- Low mass and anti-friction pivots permit tracking on warped and eccentric records.

## USES

The new lightweight pickups and tone arm (MI-11874 series and 11885-A respectively) have been designed to fulfill the need for a high-quality broadcast pickup combination for playing fine groove records and standard transcriptions. A popular application of this new design is in combination with present Universal Pickups and RCA BQ-2B and 70-Series Turntables.

In such installations, the new unit provides the broadcaster with pickup and tone arm facilities for groove sizes associated with all three speeds. 70-Series Turntables are easily modified for the 45 rpm speed by means of MI-11883 Kit.

## DESCRIPTION

The lightweight tone arm is designed to function with two diamond stylus sizes (1 mil stylus for fine groove and 2 $\frac{1}{2}$  mil stylus for standard transcription and 78 rpm records). These are readily interchangeable as "plug-in" units.

Tone arm resonances have been carefully placed so that they are outside of the operating frequency range of the systems, thus assuring smooth response characteristics. Distortion due to tracking error in the arm and pickup has been reduced to a minimum by careful design. The anti-friction vertical and lateral pivots and

low mass allow the tone arm to track warped and eccentric records.

The required stylus forces are only a fraction of what was formerly considered necessary, thus assuring longer life for both the stylus and the record. Design of the pickup system permits interchange of the magnetic heads without necessitating any adjustment for correct stylus pressure. The stylus is readily visible, providing means for accurately spotting the pickup on the record.

**LIGHTWEIGHT TONE ARM (Cont'd)**

**SPECIFICATIONS**

Tracking Error, 16-inch Record (C. D. 12").....4° max.  
 Pivot Bearings.....Anti-resonant bearings in vertical and horizontal planes  
 Tone Arm Head Receptacle.....Quick-lock, plug-in type  
 Construction of Arm.....Aluminum casting  
 Length of Arm.....15"  
 Width of Arm.....Tapered 1½" to ¾"  
 Height of Arm.....Tapered ⅝" to 9/32"  
 Approx. Shipping Weight (arm, assembly, etc.).....3 lbs.  
 Mounting.....Approx. 12" from spindle center

**Stock Identification:**

Tone Arm (less pickup heads) includes assembly complete with tone arm rest and mounting hardware.....MI-11885-A



70-F Turntable with Pickup and Tone Arm installed at rear

**LIGHTWEIGHT PICKUP HEADS**

**MI-11874-4 AND MI-11874-5**

**SPECIFICATIONS**

**Lightweight Lateral Magnetic Pickups**

Output Pickup Impedance.....135 ohms @ 1000 cycles  
 Load Impedance.....Filter Output should be connected to unloaded input transformer of amplifier designed to operate from 250 ohm source (BA-21A or BA-12A).  
 Compensation Required.....MI-11888 Filter  
 Frequency Response.....(See curve)  
 Voltage Output.....Open circuit voltage at terminals of pickup head, reproducing 1000 cycle band of 6.1 cm/sec. test record is 11 millivolts.  
 Output Level at Filter Output.....Approx. -65 dbm  
 Hum Level.....-120 dbm  
 Pickup Weight.....MI-11874-4 (0.37 oz.); MI-11874-5 (0.51 oz.)  
 Stylus Force in combination with Tone Arm, MI-11885-A:  
 MI-11874-4.....8 grams      MI-11874-5.....12 grams  
 Stylus Tip Radius (Polished Diamond Stylus):  
 MI-11874-4 (for fine groove).....1.0 mil  
 MI-11874-5 (standard transcriptions).....2.5 mils  
 Overall Dimensions (plug-in pickup heads):  
 Excluding contact pins.....Width ¾", Depth ¾", Thickness 7/16"  
 Stock Identification:  
 1 mil, Pickup, Fine Groove (color, Red).....MI-11874-4  
 2.5 mil, Pickup, St'd Transcription (color, Green).....MI-11874-5

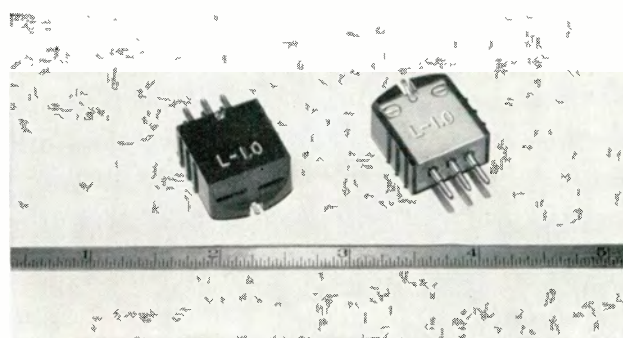

Plug-in Type Pickup Head, MI-11874-4

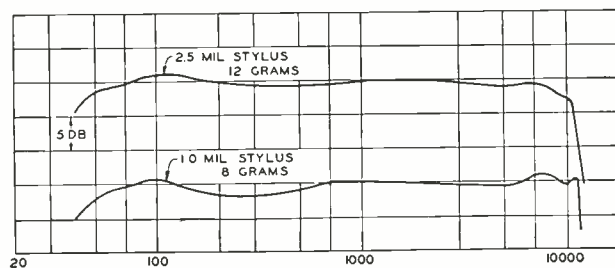

Typical response of Pickup, Tone Arm and Filter

See chart on page 89 for Equipment Combinations required for various records and transcriptions.



# PICKUP EQUALIZER

MI-11888



## FEATURES

- Adjustable high frequency response
- Follows NARTB curve
- Insensitive to hum pick-up
- Economical
- Compact—easy to mount in transcription turntables

## USES

The MI-11888 Pickup Equalizer is used to filter the re-created audio frequencies of transcriptions before introduction into the audio amplifier system of broadcast and TV stations to achieve the most desirable response over the entire audio frequency range. The equalizer may be mounted in the RCA Type 70-series or the BQ-2B transcription turntables and is designed for use with the MI-11874-4 Pickup Head for the reproduction of 45 or 33 $\frac{1}{3}$  rpm lateral cut fine groove records and the MI-11874-5 Pickup Head for the reproduction of 78 or 33 $\frac{1}{3}$  rpm lateral cut standard groove records.

## DESCRIPTION

The MI-11888 Pickup Equalizer consists of a capacitor-resistor network mounted on a plate, and separate dial plate, control knob, and hardware for mounting it in a transcription turntable. The right hand front corner of RCA turntables has been designated as best site for the equalizer in order to reduce noise pickup to the lowest possible value.

The equalizer is designed to be used with any amplifier having an unloaded input transformer and which has a flat response when operated from a 150 ohm source. Examples of this type of amplifier are the RCA 12A Booster Amplifier, the BA-12A Preamplifier, the BA-24A Monitoring Amplifier and the microphone input of any RCA consolette. In order to compensate for variations in transcriptions, three responses can be chosen: (1) flat, (2) increased high frequencies, or (3) decreased high frequencies.

## SPECIFICATIONS

- Frequency Response.....Variable over range of 30 to 10,000 cycles  
(see response curves)
- Output Level:  
At 150 Ohms.....Approximately -65 dbm  
(measured using RCA Test Record 12-5-51  
at 1000 cycle reference level)
- Output Impedance.....150 ohms
- Noise Level.....Less than -120 dbm
- Load Impedance.....The output of the filter should be connected to the unloaded input transformer of an amplifier having a flat response and designed for operation from a 150 ohm source.
- Dimensions Overall.....3 $\frac{5}{16}$ " long x 2 $\frac{7}{8}$ " wide x 5 $\frac{1}{2}$ " high
- Weight .....3 $\frac{1}{4}$  lbs.
- Stock Identification .....MI-11888

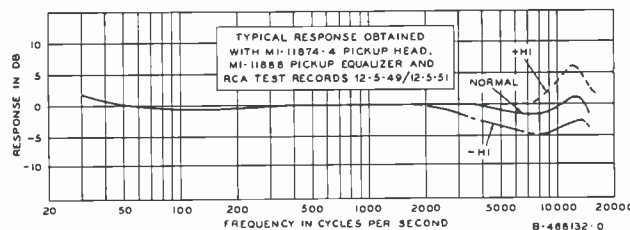

# 45 RPM CONVERSION KIT

MI-11883

## FEATURES

- Simple to add to present RCA turntables
- Quick speed changes
- Rugged construction for long service
- Quiet operation
- Accessory fine groove pickup and tone arm available

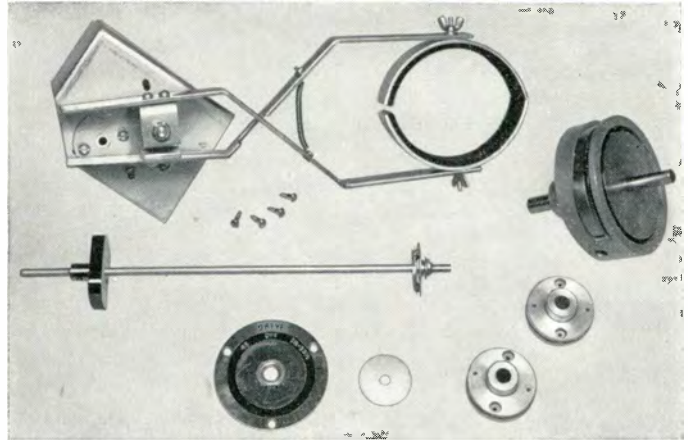

## DESCRIPTION

The 45 RPM Conversion Kit is made available to broadcasters for playing the new RCA 45 rpm records on any type 70-C or 70-D Transcription Turntable. The modification kit is easy to add to existing turntable and requires minimum investment by eliminating the expense of additional turntables. The kit consists of a ball-type speed reducer which is installed between the two flexible couplings in the main drive shaft of the 70-D turntable. In one position, the ball reducer is inoperative and the shaft is driven straight through at 78 rpm. In the other position, the ball reducer drives the shaft and flywheel at 45 rpm. The over-

riding spring clutch is built into the new mechanism and is operative in both positions.

Speed change is accomplished by turning the motor control knob on the turntable deck. It may be shifted in either direction while the turntable is running. Three positions are provided: (1) an "Off" position which completely shuts down turntable by turning off motor, (2) a "78-33 $\frac{1}{3}$ " rpm position which permits either speed by use of speed-change lever on turntable and (3) "45" rpm position which permits this speed with speed-change lever set at "78".

Also required but not included in this kit, is a second tone arm for fine groove playback (MI-11885-A).

## SPECIFICATIONS

Approximate Weight, Unpacked.....6 $\frac{1}{2}$  lbs.

Stock Identification .....MI-11883  
 (Kit includes clutch assembly (speed changer), arm assembly (brake), switch and cam shaft assembly, dial plate, 2 couplings and adapter hub.)

### Accessories

Lightweight Tone Arm.....MI-11885-A  
 1 Mil Pickup for Fine Grooves.....MI-11874-4  
 2.5 Mil Pickup for Standard Transcription.....MI-11874-5  
 Pickup Equalizer .....MI-11888



# 45 R.P.M. RECORD ADAPTOR

## MI-11886



Arrow above points to the MI-11886, 45 RPM Adaptor, mounted on the 70-D Turntable

The MI-11886 Adaptor Plate is designed for use in playing 45 rpm records on standard transcription turntables. It adapts the turntable to accommodate 45 rpm records, but does not convert driving speed.

Constructed in a single, one-piece unit, the Adaptor Plate consists of an aluminum disc, 9 inches in diameter, with a center hub which adapts the turntable spindle to the 45 rpm record hole size. The disc surface is lined with felt from the outer edge to an inner diameter of  $3\frac{3}{8}$  inches.

Record slippage due to pickup drag is eliminated by the felt covering on the disc surface. Records with as much as  $\frac{1}{2}$  inch of warp may be played without difficulty.

Stock Identification .....MI-11886

### TABLE FOR USE IN DETERMINING REPRODUCING EQUIPMENT REQUIRED TO PLAY DESIRED TYPES OF RECORDINGS

TYPE OF RECORDS TO BE PLAYED	REPRODUCING EQUIPMENT REQUIRED
Lateral transcriptions, 78 rpm records and fine groove records	MI-11885-A Lightweight Tone Arm MI-11874-4 1 Mil Lightweight Pickup Head MI-11874-5 2.5 Mil Lightweight Pickup Head MI-11888 *MI-4975 or MI-11887
Lateral transcriptions and 78 rpm records	MI-11885-A Lightweight Tone Arm MI-11874-5 2.5 Mil Lightweight Pickup Head MI-11888 Reproducing Filter
Fine groove records only	MI-11885-A Lightweight Tone Arm MI-11874-4 1 Mil Lightweight Pickup Head MI-11888

\* Filter available from existing equipment may be used.



# AUTOMATIC TURNTABLES

TYPES BQ-101 & BQ-102

## FEATURES

- Simple, more efficient handling of records in studio programming
- High record capacity—60 records or 120 selections—at your finger tips
- Automatic record cueing
- Remote control—random or sequential type record changers
- Longer pickup head life
- Less handling—longer record life
- Self-contained power supply
- Preset record selection
- Conserves valuable control room space

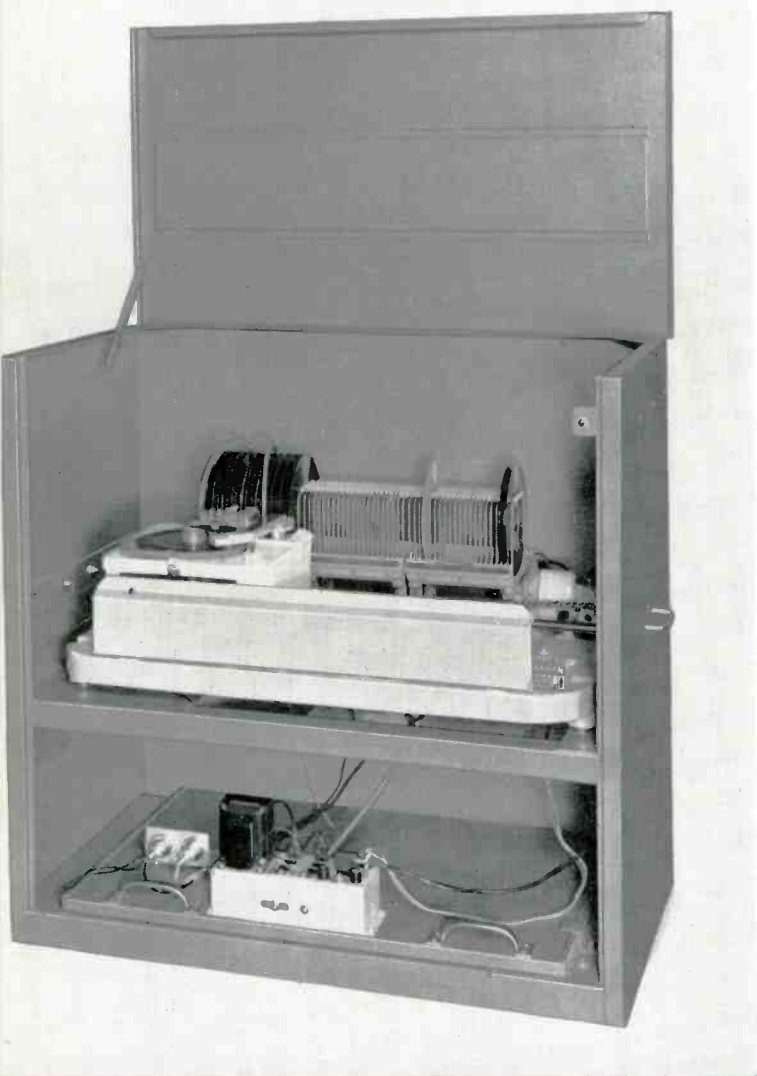

## USES

RCA's Automatic Turntables—the Type BQ-101 for fixed sequential play and the Type BQ-102 for random selection play—provide high record capacity and an efficient, accurate and economical means of record programming and handling. Both automatic turntables provide a means of playing a maximum of 60 (120 sides) 45 rpm records on a push button control basis.

The new type turntables offer greater operating efficiency for the broadcast audio studio. Not only do they conserve control room space, but the capacity of the changer allows for the loading of the machine at relatively infrequent intervals. A savings results from decreased record handling and increased record life. Pickup head life is also increased since the exact placement of the styli is accomplished by an exact and gentle mechanical motion. This avoids broken diamonds and also results in less record damage than is possible by human operation. Less skilled operating personnel are able to operate the new type turntables.

**DESCRIPTION**

The BQ-101 and BQ-102 Automatic Turntables consist of two pieces of equipment—the record handling and playing mechanism, and a separate control unit. The former consists of the record handling and playing mechanism, junction box, self-contained 24-volt power supply and a muting relay all housed in a metal cabinet 35¼ inches wide, 34¼ inches high and 21½ inches deep. A pickup equalizer, not supplied as part of the equipment, may also be mounted in this cabinet. In addition to the above equipment, the Type BQ-102 turntable also has a pulse code receiver.

The control box contains the control circuits with the necessary push buttons for record selection and the functions of reject, start, etc., with suitable lamp indications of the operational status of the equipment. The BQ-102 has an etched aluminum control panel 10 inches wide by 14¼ inches high, designed so that two such control panels can be accommodated in the BC-5A console housing. This control unit may also be rack mounted or set in other console housing equipment in the studio as desired.

Access to the record handling and playing mechanism is gained through a removable front panel. When the front panel is removed, service lights illuminate the interior. All components are easily accessible. A hinged top provides further access to units within the housing for routine playing and record changing operations. When the housing is "buttoned up" a small door in the front panel provides access to power switches. Cable access doors are located at the rear and in each side of the housing.

The record handling mechanism is mounted on a shelf within the housing by means of shock mounts. It comprises record storage racks, a selection device, and a traversing turntable mechanism. The record storage racks provide storage for 60 records (120 sides). The random selection of the records in the case of the BQ-102 is accomplished by means of electro-magnetically activated selecting fingers. The fingers, 120 total, are accurately positioned with respect to the record storage racks. The turntable and record transfer arm assembly are transported on two guide rails, to the activated selecting finger, or to the next record in the sequential play BQ-101 equipment. Then a transfer arm grasps the record and places it on the turntable. The record turntable is puck driven. The tone arm accepts standard RETMA pickup mountings. The base on which the entire record handling mechanism is mounted is sturdily constructed of cast iron. This provides the high inertia necessary for smooth operation.

In the base of the housing is mounted the junction box which houses control circuits, the d-c power supply and the

fuses. The junction box serves to distribute electrical power, both a-c and d-c to the various functioning parts of the turntable. In the BQ-102 model there is also a pulse receiver or transmitter which contains relay and stepping switches. They are controlled by pulses received from the control box. The pulses are processed by the receiver into a form which is used to control the selector electro magnets. In addition to the 24-volt d-c power supplied furnished with the BQ-101, there is also a 26 volt a-c power supply for the pulse transmitter in the BQ-102. Both turntables are designed to be operated from a line-voltage source of 100 to 125 volts, 60 cycles, a-c only. The output of the equipment is normally fed to a standard equalizer and then into the preamplifier of the audio consolette.

The control box switching functions are somewhat different for the BQ-101 sequential machine and the BQ-102 random selection phonograph. The BQ-101 controls include start and reject controls, power control, indicator (ready and play) lights, and a homing switch. The BQ-102 has a power switch, start switch with illuminated pushbutton in which is located the ready light, a reject switch with play light located in it, 22 selection buttons for selecting any of the 120 record selections and a check light which will go out if selection buttons are not properly set. The random selection mechanism is controlled by means of a pulse code. The pulse code is made up of two pulse trains.

**SPECIFICATIONS**

Record Handling Capacity.....	60 records (120 sides)
Turntable Speed.....	45 rpm
Power Supply.....	100-125 volts, 60 cycles, single phase
Dimensions:	
Record Handling and Playing	
Mechanism.....	35¼" wide, 34¼" high, 21½" deep
BQ-101 Control Unit.....	6¼" wide, 2½" high, 3¾" deep
BQ-102 Control Unit.....	10" wide, 6" high, 14¾" deep
Finish.....	Light and dark umber gray
Weight:	
BQ-101 Model.....	200 lbs. (approx.)
BQ-102 Model.....	225 lbs. (approx.)
Stack Identification:	
BQ-101 (sequential selection).....	MI-11840
BQ-102 (random selection).....	MI-11841

**Accessories**

Pickup Equalizer.....	Gray 602-C
GE Variable Reluctance Cartridge, replaceable	
1.0 mil diamond stylus.....	RPX-145
GE Replacement Stylus Tip, 1.0 mil diamond.....	RPJ-01D

# TAPE-RECORDER

## TYPE SRT-2

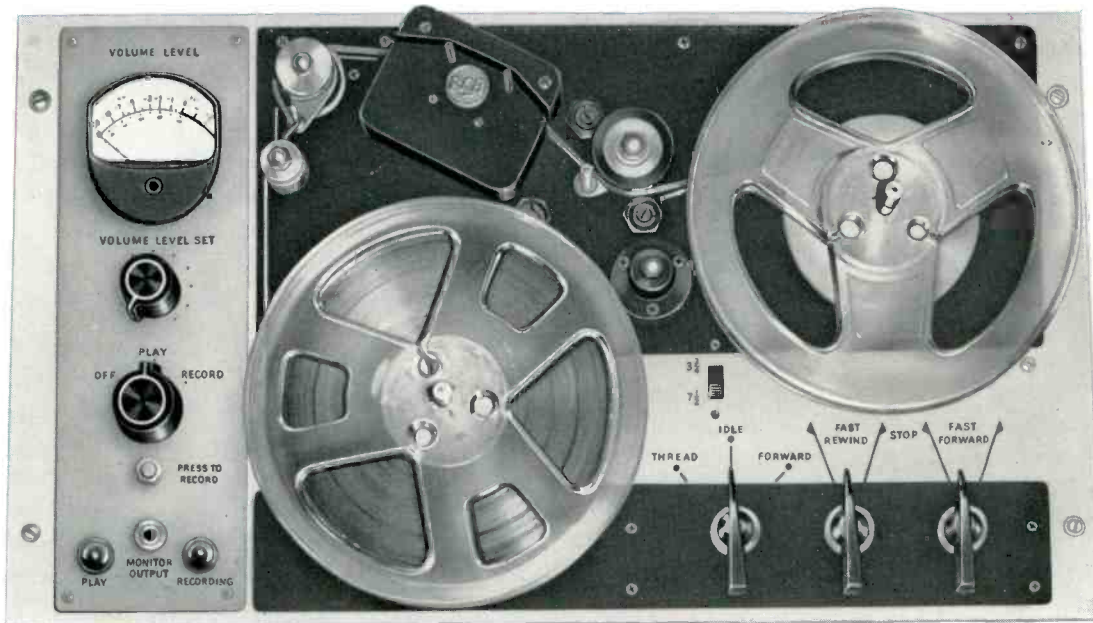

### FEATURES

- Transistor record and playback amplifier with etched circuits
- Electro dynamic tape tensioning and braking
- 3¾ and 7½ IPS operation—by selector switch
- Excellent frequency response
- VU meter recording level indicator
- Direct synchronous motor tape drive
- Fast forward and rewind speed
- Automatic tape lift during fast rewinding
- Vertical or horizontal operation

### USES

The RCA SRT-2 Tape-Recorder is a quality unit designed and precision built by RCA for use in broadcasting systems. The unit meets professional recording requirements and is an ideal low-cost unit for broadcast studio or remote pickup use. The equipment can be used for recording any type studio program, and for delayed broadcasts, taped interviews or round table discussions. It offers a wide variety of service for auditions and air checks for clients and agencies. This equipment also provides an opportunity to build and recheck air shows for future use.

The SRT-2 has many advanced mechanical, electrical, and functional features including a transistor record and playback amplifier with etched circuits, dual recording speeds, electro dynamic tape tensioning and braking, automatic

tape lift during fast rewind, VU meter for recording level indication, and direct synchronous motor tape drive.

The tape recorder is designed primarily for rack mounting; or portable operation with the MI-11976 Portable Carrying Case. It can be operated in a vertical or horizontal position. It will record from a studio microphone, radio tuner, or turntable pickups. Any low impedance broadcast microphone can be used. Connection should be made directly to the Type XL input receptacle provided. A high impedance unbalanced bridging input is also provided. Any high quality, high impedance earphones may be used to monitor either the record or playback functions. These items may all be procured as accessories.



**DESCRIPTION**

The SRT-2 Tape-Recorder is a panel-mounted instrument with transport mechanism, record-reproduce and erase head, VU meter, monitoring output, and operating controls all conveniently mounted on the motor board or panel. The oscillator and power supply chassis is mounted back of the transport mechanism. The amplifier etched circuit board is mounted at right angles to the panel together with the microphone input receptacle and the connection terminal board. One RCA plastic 7-inch tape reel holding up to 1200 feet of tape is supplied with each unit. The a-c cord is attached to the power supply chassis, and one microphone connector and one phone plug are supplied with the unit.

The SRT-2 has a three-stage transistor amplifier. The tape transport mechanism includes three motors. The capstan motor is a two-speed synchronous motor, 720 or 360 rpm. The two reel drive motors are of the hysteresis type and identical. The panel has a switch for selecting the capstan motor speed. The low speed provides a tape speed of 3¼ IPS and the high speed, 7½ IPS. The panel also contains three switches to control the tape motion and an electrical interlock which stops the recorder should the tape break or run out. The unit makes no use of clutches, brakes or belts requiring adjustment, but has an electro-

dynamic tape braking and tape tensioning system. The tape recorder has provisions for slot loading and automatic tape lift for fast rewind and forward.

Other convenient operating controls on the panel include the VU meter for setting the recording level, a volume control for adjusting the recording level and output level when tape is being reproduced. The power switch is combined with the switch controlling the play-record operations. This switch cannot be accidentally turned to the record position since a press-to-record interlock is provided. A monitoring jack and two indicator lights to indicate the function of the recorder, play or record are mounted along the bottom left hand corner of the panel.

Two accessory transformers are required if balanced low impedance input and output is desired. They are the input transformer MI-11776 and the output transformer, MI-11435. Sockets are provided adjacent to the amplifier for plugging in the transformers. The SRT-2 is designed with all input and output circuits unbalanced to ground.

Seven-inch reels are capable of being wound or re-wound in 45 seconds at the fast forward or rewind speed. The tape-recorder chassis when mounted vertically as in rack mounting, measures 18 inches wide, 10½ inches high and 8¼ inches deep overall and weighs 33 pounds.

**SPECIFICATIONS**

**Panel Controls**

Panel Designation	Description	Function
VOLUME LEVEL SET	Control— 1-10 positions	Regulates gain
OFF—PLAY— RECORD	Switch, 3 positions	Turns equipment on. Selects operation desired PLAY or RECORD
PRESS-TO-RECORD	Pushbutton	Safety lock
PLAY	Indicator light, green	Indicates type of operation—playback
RECORDING	Indicator light, red	Indicates type of operation—recording. Both lights on
MONITOR OUTPUT	Phone jack	Headphones for monitoring incoming signal
3¾—7½	Switch, 2 positions	Selects speed
THREAD—IDLE— FORWARD	Switch, 3 positions	Position for threading the tape Intermediate position or Standby Tape forward at selected speed
FAST—REWIND— STOP	Switch, 2 positions	Rewinds tape to supply reel at fast speed
STOP FAST FORWARD	Switch, 2 positions	Transfers tape from supply reel at high speed

Recording Speeds.....7½-inches per second and 3½-inches per second by selector switch  
 Rewind Speed and Fast Forward....1200 ft. of tape (7" reel) 45 seconds  
 Frequency Response:  
 Record and Playback.....±3 db from 40 to 12,000 cps  
 Flutter and Wow.....Less than 0.2%  
 Signal-to-Noise Ratio.....Better than 50 db with less than 3% distortion (flat response)  
 Inputs.....High impedance, bridging input  
 Microphone, low impedance  
 Outputs.....0.6 volts into 10,000 ohms or more from 0 level tape recording  
 High impedance monitoring jack 150/600 ohms balanced (with plug-in transformer MI-11435)

Tube and Transistors:  
 Bias Oscillator Tube .....1—12BH7  
 Amplifier Transistors.....1—2N175, 3—2N109  
 Mounting.....Horizontal or vertical in Cabinet or Relay Rack  
 Finish.....Black and chrome  
 Power Requirements.....110 volts, 60 cycle a-c, 90 watts  
 Dimensions.....19" wide x 10½" high x 8½" deep  
 Weight .....35 lbs.  
 Stock Identification .....MI-12825

**Accessory Equipment**

Input Transformer .....MI-11776  
 Output Transformer .....MI-11435  
 Portable Carrying Case.....MI-11976  
 Double Headset (24,000 ohm impedance).....MI-11750  
 Single Headset (900 ohm impedance).....MI-11749

# AM-FM RADIO TUNER

TYPE ST-4



## FEATURES

- Extended audio frequency range
- Extremely sensitive; minimum distortion
- High signal-to-noise ratio
- Drift-free automatic frequency control; variable control
- Equipped with a tuning eye for easy tuning
- Cathode-follower output stage
- Minimum radiation—well within FCC and RETMA requirements
- Low impedance loop antenna

## USES

The RCA ST-4 AM/FM Radio Tuner is designed for use where a central radio receiver is to be used with a sound distribution system. Due to its wide range frequency characteristics and low distortion rating, the ST-4 Tuner is especially adaptable to broadcast systems. It is also handy for off-air monitoring. When connected to a high-fidelity audio amplifier and speaker it will provide radio reception at its very finest. Special care has been taken in minimizing radiation to prevent interference with other radio receivers and television sets. Radiation is well within the FCC and RETMA Limits over the entire FM band.

**DESCRIPTION**

The ST-4 AM/FM Radio Tuner is carefully designed to meet rigid specifications and conservatively rated for flawless performance. It is a 13 tube (including tuning eye and rectifier) AM/FM Tuner with a FM tuning range of 88-108 megacycles and an AM tuning range of 540-1600 kilocycles. The tuner is designed for use with an audio amplifier with 10,000 ohms or greater input impedance. A tuning eye incorporated on the slide-rule type station selector provides accurate, pin-point tuning with minimum distortion. A simple screwdriver adjustment permits setting the level of the tuner output at the optimum level. This feature eliminates the use of two volume controls, making it necessary to use only the preamplifier volume control. Incorporation of a cathode-follower output stage permits the use of up to 200 feet of shielded cable between tuner and preamplifier. The output of the tuner is fed into a standard phonojack mounted in the rear chassis apron.

As an AM Receiver the tube complement consists of a 6BA6 r-f amplifier, 6BE6 AM oscillator-mixer, 6AU6 1st i-f amplifier, 6BA6 2nd i-f amplifier, 12AT7 detector and cathode follower.

As an FM tuner the tube complement consists of a 6BQ7A r-f amplifier, 6U8 FM mixer, and automatic frequency control, 6AU6 1st i-f amplifier, 6BA6 2nd i-f amplifier, 2 6AU6 limiters, 6AL5 detector, 6C4 oscillator, 6E5 tuning eye, and a 6X5-GT rectifier tube.

Three simple controls are used for operating the ST-4 Tuner. One control—volume output level—is set once by a screwdriver adjustment at optimum output level and rarely needs to be adjusted. The knob on the right of the tuner is for station tuning. Stations tuned are clearly indicated on the lighted, slide-rule type dial. The selector control is on the left side of the tuner. It has five positions—OFF, AM, FM, FM-1, FM-2. Control of frequency drift is provided through a variable AFC. This choice of high or low AFC level permits lock-in on a weak station adjacent to a strong station.

A standard a-c receptacle mounted on the rear apron is wired in the circuit so that a remote phonograph or a radio amplifier may be plugged in to obtain a-c power.

**SPECIFICATIONS**

Audio Frequency Response.....Flat  $\pm 2$  db from 50 to 15,000 cps

Audio Frequency Response Overall.....20 to 20,000

Tuning Range:

FM.....88-108 mc

AM.....540-1600 kc

Intermediate Frequencies:

FM.....20.6 mc

AM.....455 kc

Sensitivity:

FM.....10 microvolts for 20 db noise quieting (on 300 ohm input)

AM.....12 microvolts for 0.5 volt audio output

Audio Output:

FM.....1.5 v. with 75 kc deviation

AM.....1.0 v. with 100% modulation

Output Impedance.....For use with audio amplifier of 10,000 ohms or greater impedance

Oscillator Radiation.....Well within the FCC limit for maximum oscillator radiation over the entire FM band

Signal to Noise.....60.5 db  
(75 kc deviation 20 mv signal)

Distortion.....1.5% at 1.5 volt output  
(75 kc deviation 20 mv signal, 400 cycles)

Power Required.....90-130 v. 50/60 cps, a-c, 65 watts

Controls.....Tuning Selector—Off, AM, FM, FM-1, FM-2  
Level Set (screwdriver adjustment)

Recommended Audio Cable Length....Up to 200 feet of shielded cable; or low-impedance cable up to 10,000 mmf total distributed capacitance

Antenna Inputs:

FM.....Two inputs, 300 or 72 ohms

AM.....Low impedance, high impedance

Indor Antenna Supplied.....Low-impedance, low-noise loop

Tube Complement:

1 6BQ7A	FM R.F.	1 6AL5	FM Detector
1 6U8	FM Mixer, AFC	1 6BE6	AM Osc-mixer
3 6AU6	FM I.F., 1st Limiter, 2nd Limiter	1 12AT7	AM Detector, Cathode Follower
2 6BA6	FM I.F., AM R.F.	1 6X5-GT	Rectifier
1 6C4	FM Osc.	1 6E5	Tuning Eye

Dimensions.....6 1/2" high, 14 1/4" wide, 12 3/4" deep

Weight.....17 lbs. (shipping)

Stock Identification .....MI-12115-A

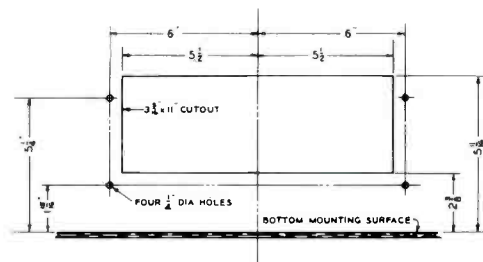



# LOUDSPEAKERS

RCA offers to broadcasters a complete line of studio and station monitoring loudspeakers for use in monitoring and auditioning booths, hallway installations, talk-back applications, elevators and executives' offices. All RCA loudspeakers are designed to handle adequate power for the particular application for which they are designed. The LC-1A, representing the greatest advance in loudspeaker design, is obtainable for use in a choice of cabinet styles and finishes, thereby making it possible to conform to any of several interior decorating schemes. In addition, the LC-1A speaker mechanism may be obtained for those applications where it is desirable to use a special type, or custom-made, mounting.

In order to serve the wide variety of needs for loudspeakers around broadcasting stations, there is also included in this line a choice of permanent-magnet loudspeaker mechanisms. These mechanisms are intended to be mounted in one of the wall-mounting speaker housings. Loudspeaker Impedance Matching Transformers, MI-12368, MI-12369 and MI-11731 are designed for coupling a wide variety of outputs to these and many other types of loudspeakers. The quick-selection chart below provides a convenient reference for selecting the proper RCA loudspeaker combination.

## CHART SHOWING SPEAKER APPLICATIONS, RECOMMENDED HOUSINGS, AND SPECIFICATIONS

MI Number	Diameter (Inches)	Uses	Power Handling Capacity (Watts)	Frequency Range	Voice Coil Impedance (Ohms)	Floor Cabinet	Wall Housing
MI-11411-A LC-1A	15	Master program monitor, executive offices, clients' rooms, reception rooms, any application requiring maximum quality of sound reproduction	20	50-16,000 cps	15	MI-12464-B (Blonde) MI-12464-M (Mahogany)	MI-11406
MI-12654 SL-123	12	Program monitoring, executive offices, clients' rooms, reception rooms	15	40-18,000 cps	8	MI-12463-M (Mahogany)	MI-11407-A
MI-12458 SL-12	12	Program monitoring, executive offices, clients' rooms, reception rooms	10	50-16,000 cps	8	MI-12463-M (Mahogany)	MI-11407-A
MI-12418-B	12	Utility monitoring, spare program monitor, studio and announce booth cue, offices	15	50-8500 cps	8		MI-13253 MI-11407-A
MI-11408	10	Utility monitoring, spare program monitor, studio and announce booth, cue, offices	10	80-7000 cps	4		MI-11407-A
MI-6333-D	10	Public Address, Studio talk-back, and intercom systems	20	60-7000 cps	6		MI-13253 with MI-13245-A
MI-12454 MI-12454-A	8	Turntable cueing, dressing rooms, intercom, paging systems	8	80-8500 cps	4		MI-6104

# 15-INCH SPEAKER MECHANISM

TYPE LC-1A



## FEATURES

- Excellent frequency response, uniform 50-15,000 cycles
- Wide angle sound radiation of all frequencies
- Low non-linear distortion
- Ideal for monitoring AM-FM television programs
- Alnico V magnets

## USES

The LC-1A is a "Broadcast Quality" loudspeaker with a low distortion, wide angle distribution, of extended frequency range, and specifically designed for use in recording studios, executive offices, reception rooms, sponsors' booths or any location that warrants a pleasant setting and tasteful styling.

For applications where it is desired to mount the mechanism on a wall baffle, ceiling, etc., the speaker mechanism may be used with assurance that the entire frequency range will be realized. The speaker's outstanding performance makes it ideal for wide frequency range wide angle radiation.

## DESCRIPTION

The LC-1A is a duo-cone speaker mechanism of the direct radiated type, consisting of high and low frequency units mounted co-axially together. The 2" high frequency cone and the aluminum wound voice coil has a low mass utilizing the wide angle of the shallow, low frequency cone to effect its remarkable directional pattern (see curve). An equilibrium has been reached between the electrical and mechanical design to impart a high frequency radiation of 120° arc with a loss of approximately 6 db at 15,000 cps. This eliminates the conventional "beam effect" usually experienced at this frequency.

## DETAILS OF THE RCA DUO-CONE DESIGN

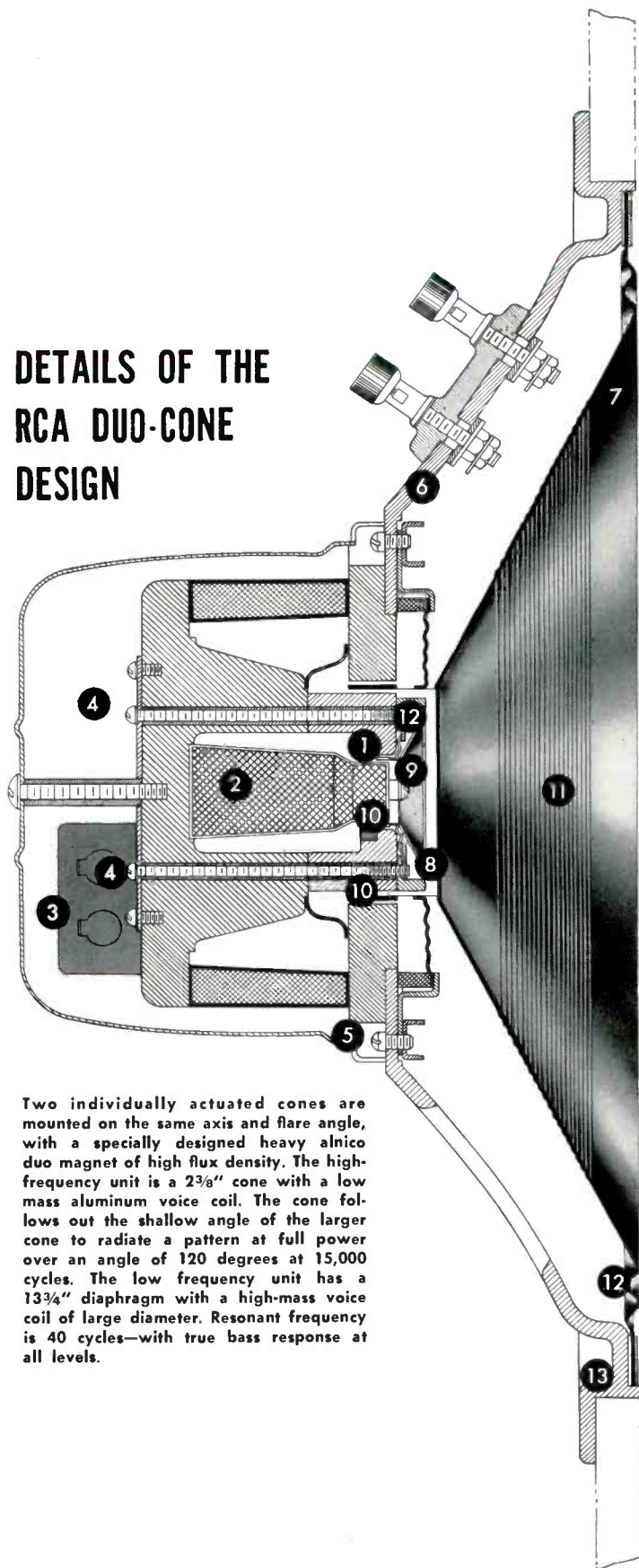

Two individually actuated cones are mounted on the same axis and flare angle, with a specially designed heavy alnico duo magnet of high flux density. The high-frequency unit is a 2 $\frac{3}{8}$ " cone with a low mass aluminum voice coil. The cone follows out the shallow angle of the larger cone to radiate a pattern at full power over an angle of 120 degrees at 15,000 cycles. The low frequency unit has a 13 $\frac{3}{4}$ " diaphragm with a high-mass voice coil of large diameter. Resonant frequency is 40 cycles—with true bass response at all levels.

- 1 H-f voice coil, aluminum wire-wound, to deliver full h-f range.
- 2 Heavy Alnico V magnet.
- 3 Cross-over condenser.
- 4 Centering adjustment for h-f cone.
- 5 Centering adjustment for l-f cone.
- 6 Sturdy die-cast aluminum frame.
- 7 Shallow cone for smooth response and greater angle of distribution.
- 8 H-f and l-f cones coaxially-mounted, mechanically independent.
- 9 H-f cone. Diaphragm diameter only 2 $\frac{3}{8}$ ". Wide-angle distribution to 15,000 cycles.
- 10 Ample gap clearances.
- 11 Massive 15" l-f cone. Bass response 35 to 2000 cycles at all volume levels.
- 12 Cone rim treated to minimize edge reflections for smoother response.
- 13 Offset mount eliminates front cavity—insures smooth response.



The low frequency system employs a large diaphragm with a high mass voice coil and produces the most desirable directional pattern with a handling capacity of 20 watts. Low distortion has been accomplished by a carefully designed balance of many contributing factors. Distortion usually experienced when handling large power in the 100-1,000 cycles range is eliminated by using a high mass coil and a massive rigid cone, coupled with a low fundamental frequency peak of 40 to 50 cycles. Above this frequency the stiffness of the suspension system of the cone does not appreciably affect the velocity and, therefore, minimizes distortion.

A feature of construction is the use of acoustical domes—largely responsible for smooth response. The series of domes placed on the speaker's large cone breaks up the unit's symmetry and eliminates the interference normally characteristic of the symmetrical shape without sacrifice of either highs or lows.

The cross-over network utilizes the physical characteristics of the cones to mutually vibrate in unison over

the cross-over frequency region and merely employs one capacitor in the high frequency unit to limit its current at low frequencies.

**SPECIFICATIONS**

**LC-1A Speaker Mechanism**

Impedance (nominal).....	15 ohms
Frequency Response (see curve).....	40-15,000 cps
Directional Characteristic.....	See curve
Power Handling Capacity.....	20 watts
Non-linear Distortion (for 10 watt output, 50-15,000 cycles)	Less than 4% at 60 cycles
Weight (unpacked).....	.21 lbs.
Dimensions:	
Diameter (cone) .....	15 5/16"
Diameter (bolt fixing circle).....	16 1/4"
Diameter (overall frame).....	17"
Stock Identification .....	MI-11411-A
(Mechanism only)	

**Accessories**

LC-1A Speaker Cabinet (Blonde).....	MI-12464-B
LC-1A Speaker Cabinet (Mahogany).....	MI-12464-M
LC-1A Speaker Cabinet (Umber Gray).....	MI-11407
LC-1A Wall Speaker Housing.....	MI-11406
Power Attenuator .....	MI-11708-A

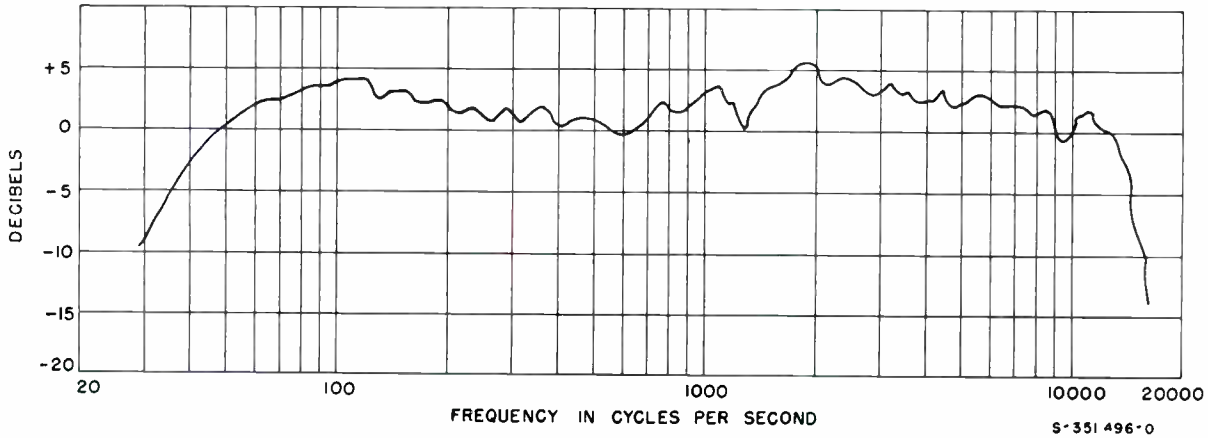

Frequency Response Curve of LC-1A Speaker.

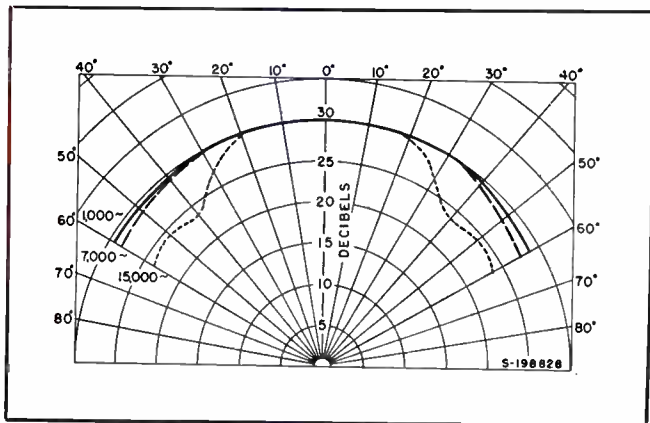

Directional Characteristics of LC-1A Speaker.

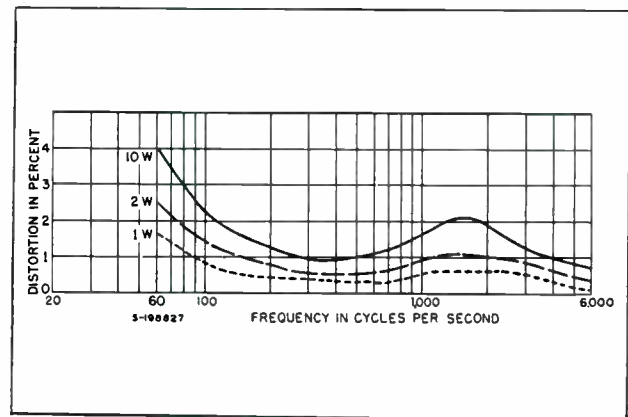

Harmonic Distortion of LC-1A Speaker.

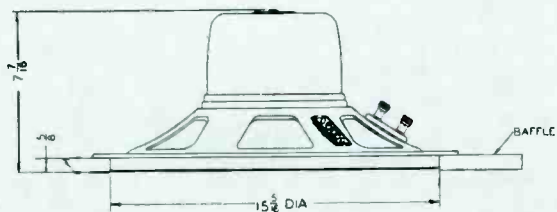
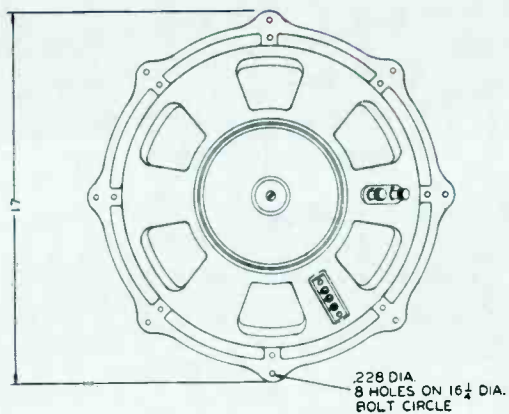

**Dimensions of LC-1A Speaker**



**Rear View of LC-1A Speaker**

**ENCLOSURES FOR LC-1A SPEAKER MECHANISM**



The MI-12464-B and MI-12464-M cabinets may be mounted in a horizontal position as shown at left. Regardless of decor arrangement the LC-1A Speaker mounted in these cabinets performs at its best



The LC-1A Speaker Floor Cabinet, MI-12464-B, is constructed of blonde birch wood. It is ideal for obtaining maximum performance with the LC-1A. This cabinet is also available in mahogany finish as MI-12464-M



The MI-11406 Wall Mount Speaker Housing accommodates the LC-1A Speaker Mechanism. This housing has been popular with broadcasters for many years as a space-saving unit which maintains the LC-1A Speaker "Broadcast Quality"

# 12-INCH SPEAKER MECHANISM

## TYPE SL-12



### FEATURES

- Excellent frequency response—50 to 16,000 cycles
- Low non-linear distortion
- Ideal for monitoring AM, FM and television programs
- Alnico V magnets

### USES

The Type SL-12 Speaker Mechanism provides "Broadcast Quality" reproduction when used with its companion floor housings MI-12463-B or MI-12463-M. This combination may be used in executive offices, reception rooms, sponsors' booths or any location requiring a pleasant setting and tasteful styling.

### DESCRIPTION

The SL-12 Speaker Mechanism is an extended-range single cone speaker. Its design provides uniform response from 50 to 16,000 cycles—avoiding frequency discrimination. The smooth response of the SL-12 is obtained by employing a curve-linear-shape cone of special pulp material. An outer suspension damping ring provides a matched terminating acoustical impedance. A distribution angle of more than 40° is obtained with the SL-12 Speaker Mechanism.

### SPECIFICATIONS

Voice Coil Impedance.....	8 ohms
Frequency Response.....	50 to 16,000 cycles
Power Handling Capacity.....	10 watts
Overall Diameter .....	12 7/32"
Overall Depth .....	6 5/32"
Weight .....	4 lbs.
Stock Identification .....	MI-12458

### Accessories

SL-12 Floor Cabinet (Mahogany).....	MI-12463-M
12" Wall Housing .....	MI-11407-A



# 12-INCH SPEAKER MECHANISM

## TYPE SL-123



### USES

The Type SL-123 Speaker Mechanism provides extended frequency response with excellent spatial distribution when used with its companion floor housing MI-12463-M. This combination may be used in large executive offices, reception rooms, sponsors' booths or any location requiring broadcast quality reproduction.

### DESCRIPTION

The SL-123 Speaker Mechanism is an extended-range cone speaker coupled with a highly efficient tweeter unit designed for remarkably faithful reproduction over the 40 to 18,000 cycle range with excellent spatial distribution. A special shape has been used for the curvilinear cone, and in addition the material for the cone has received particular attention. A further refinement is the damping ring in the outer suspension of both sound and tweeter cones which provides optimum acoustical impedance to effectively eliminate standing waves in the suspension and cone.

This development gives improved efficiency at the bass end and relatively smooth response at the high end of the spectrum. The method of cementing the concave center in the tweeter widens the angle of high frequency response.

### FEATURES

- Extended range tweeter has wide angle distribution
- Concave center radiator construction with off-center tweeter provide smoother cross-over response
- Uniform frequency response 40 to 18,000 cycles
- Unique rubber damping on both high and low frequency units for smoother frequency response
- Alnico V magnets
- Ideal for monitoring AM, FM and TV Program

### SPECIFICATIONS

Frequency Response.....	Uniform from 40 to 18,000 cycles. Usable response extends about 1/3 of an octave below lower value and a considerable amount above the upper value.
Axial Sensitivity.....	97 db at 4 ft. with 1 watt input
Crossover Network.....	5000 cycles
Input Impedance.....	8 ohms
Power Handling Capacity.....	15 watts
Magnet Material.....	Alnico V
Magnet Weights:	
Low Frequency.....	14.5 ozs.
High Frequency.....	1.47 ozs.
Over-all Diameter.....	12-7/32"
Mounting Data.....	8 equally spaced holes on 11 1/16" circle
Depth.....	6-5/32"
Weight.....	4 lbs.
Stock Identification.....	MI-12654

### Accessories

Floor Console Cabinet (Mahogany).....	MI-12463-M
12" Speaker Cabinet (Wall Mounting).....	MI-11407-A

# 12-INCH SPEAKER MECHANISM

MI-12418-B

## FEATURES

- High sensitivity
- Smooth frequency response
- Balanced listening characteristic
- Equipped with transformer
- Alnico V permanent magnet
- Excellent power handling capability

## USES

The MI-12418-B 12-inch Speaker Mechanism when used with its wall housing, MI-13253 or MI-11407-A is suitable for use in many occasions such as: reception rooms, corridors, offices, dressing rooms, workshops, etc. It may be used as a talk back and cue speaker in studios.

## DESCRIPTION

This is a straight edge cone permanent magnet type speaker mechanism of good sensitivity. The permanent magnet uses the new Alnico V metal, which is the best available material for the purpose. It permits high flux density in a smaller and lighter magnet, which contributes to the high efficiency of the speaker. The MI-12418-B also has the corrugated cone feature, which, by introducing just enough additional compliances, smooths and improves

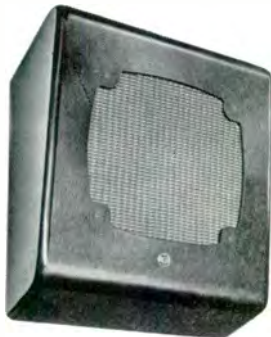

MI-13253

Wall Housing  
for use with  
12-inch Speaker  
MI-12418-B.



the frequency response characteristic. External metal parts of the MI-12418-B speaker are finished in umber gray metalustre. The speaker comes equipped with a matching transformer in place and wired to the speaker from the 6 ohm tap. Transformer impedances are 625, 1250, 2500, and 5000 ohms.

## SPECIFICATIONS

Voice Coil Impedance.....	6-8 ohms
Frequency Response.....	50 to 8500 cycles
Power Capability.....	10 watts maximum
Axial Sensitivity.....	97 db at 4 ft. with 1 watt input
Magnet Material .....	Alnico V
Diameter .....	12 1/8"
Depth .....	5 5/8"
Mounting Data.....	8 equally-spaced holes on 11 1/8" circle
Net Weight.....	4 lbs. 4 ozs.
Stock Identification .....	MI-12418-B

## Accessories

12" Wall Housing.....	MI-13253
Wall Housing .....	MI-11407-A
Transformer .....	MI-12368

# 10-INCH SPEAKER MECHANISM

MI-11408



## FEATURES

- Provides broadcasting quality monitoring in station control rooms, clients' booths and studios in conjunction with MI-11407-A Wall Housing
- Employs high-quality Alnico V permanent magnet
- Capable of handling 10 watts of undistorted output
- Excellent frequency response

## USES

The MI-11408 Speaker Mechanism with its associated Wall Housing (MI-11407-A) is designed specifically to provide economical Broadcast Monitoring. Such applications include AM/FM and TV control rooms, clients' booths, offices and studios.

## DESCRIPTION

The MI-11408 Speaker employs a high-quality Alnico V permanent magnet and is capable of producing an undistorted output of 10 watts. The frequency response characteristic is such that the mechanism will give well balanced sound when used with its companion baffle. Speaker matching transformer MI-11731 is available for connecting to an 8-ohm or 15-ohm source. (Speaker voice coil impedance is 4 ohms).

## SPECIFICATIONS

Frequency Range .....	60-7000 cycles
Power Handling Capacity.....	10 watts
Voice Coil Impedance.....	4 ohms
Overall Diameter .....	10 <sup>1</sup> / <sub>8</sub> "
Overall Depth .....	.41 <sup>1</sup> / <sub>4</sub> "
Weight (unpacked).....	2 <sup>1</sup> / <sub>8</sub> lbs.
Stock Identification .....	MI-11408

### Accessory

10" Wall Housing .....	MI-11407-A
------------------------	------------

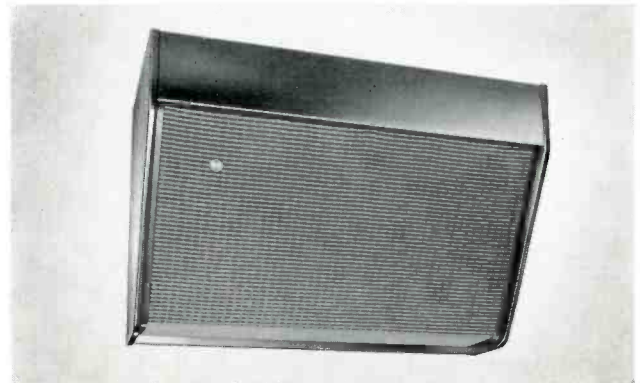

MI-11407-A Wall Housing used to house the MI-11408 Speaker Mechanism



# 10-INCH SPEAKER MECHANISM

MI-6333-D



## FEATURES

- Good frequency range
- High power handling capacity
- Corrugated cone for smooth response
- Alnico V magnet
- Rugged construction
- Extremely high efficiency
- Moisture-resistant cone and voice coil

## USES

The MI-6333-D 10-inch cone-type speaker is particularly useful for those applications where large power handling is necessary such as in public address, studio talk-back, and intercom systems. It reproduces the human voice with unusual clarity and is ideal for use in noisy locations. The MI-6333-D speaker has a frequency response characteristic calculated to give optimum performance and tonal balance when used with the 12-inch wooden MI-13253 Wall Housing and the MI-13245-A Reducing Baffle.

## DESCRIPTION

The MI-6333-D Speaker is a 10-inch permanent magnet cone type mechanism. The cone is of one piece and is corrugated, which results in smoother characteristics and improved performance. The permanent magnet is of Alnico V metal insuring permanence and stability of the field. To make the speaker more rugged, the cone is made moisture-resistant and a baking-type resin cement is used throughout. This speaker has an unusually good frequency response characteristic and capably handles large amounts of power. The gap flux density is high, contributing to the speaker's high sensitivity.

## SPECIFICATIONS

Impedance.....	60 ohms at 400 cycles
Frequency Range.....	60 to 7000 cycles
Power Capacity.....	20 watts
Axial Sensitivity.....	95 db at 4 ft. with 1 watt input
Gap Flux Density.....	9500 lines/cm <sup>2</sup>
Magnet.....	Alnico V
Magnet Weight.....	6.8 ozs.
Diameter.....	10¼"

Depth.....	5⅝"
Mounting Data.....	4 equally spaced 9/32" x 7/32" holes on 9⅝" circle
Net Weight.....	3½ lbs.
Shipping Weight.....	5½ lbs.
Stock Identification.....	MI-6333-D

### Accessories

12" Wall Speaker Housing.....	MI-13253
Reducing Baffle.....	MI-13245-A

# 8-INCH SPEAKER MECHANISM

MI-12454



## FEATURES

- Acoustically balanced for wall baffles
- Multi-tap matching transformer
- Built for rugged use
- Alnico V permanent magnet
- High flux density and sensitivity
- Smooth wide range response

## USES

The MI-12454 Eight-Inch Speaker is designed to fulfill requirements for all indoor sound distribution and intercommunication applications using eight-inch speaker-baffles. It may be used with any standard eight-inch baffle. It is particularly well adapted for use as a broadcast speaker when used with baffle MI-6104.

## DESCRIPTION

The MI-12354 is an eight-inch cone-type speaker with a permanent magnet field. The Alnico V magnet is the best commercially available material providing high flux density, permanence and stability with a minimum of size and weight. This carefully engineered and ruggedly built speaker has a one piece stamped steel frame which is welded to the yoke assembly and zinc plated. The cone, voice coil assembly and suspension are moisture resistant. The air gap is accurately held in alignment by means of a brass centering ring welded in position. A spring brass magnet clamp, an RCA development, holds the magnet in place without the use of cement or solder. A multi-tap line matching transformer is provided to enable the 3.2 ohm voice coil to present impedances of 700, 14,00, 4000, 8000 or 16,000 ohms to a loudspeaker line. The speaker mechanism may also be purchased without the transformer.

The response characteristic is acoustically selected to produce a balanced listening quality when the speaker is mounted in a normal size wall mounting baffle such as MI-6104.

## SPECIFICATIONS

Power Handling Capability.....	10 watts
Axial Sensitivity.....	96 db @ 4 ft. with 1 watt input
Frequency Response.....	70-13,000 cycles
Magnet Material and Weight.....	3.16 oz. Alnico V
Gap Flux Density.....	9000 lines/cm <sup>2</sup>
Voice Coil Impedance.....	3.2 ohms @ 400 cycles
Voice Coil Size.....	3/4"
Outside Diameter .....	8 1/4"
Depth .....	3 1/2"
Mounting Data.....	4 equally spaced holes on 7 5/8" bolt circle
Net Weight .....	31 oz.
Shipping Weight.....	16 to a carton—35 1/2 lbs.
Transformer Data:	
16,000 Ohms .....	Red-Black
8,000 Ohms .....	Red-Red/Black
4,000 Ohms .....	Red-Red/Yellow
1,400 Ohms .....	Black-Red/Black
700 Ohms .....	Red/Yellow-Red/Black

### Stock Identification:

8" Speaker Mechanism.....	MI-12454
8" Speaker Mechanism (less transformer).....	MI-12454-A

### Accessories

8" Wall Speaker Housing.....	MI-6104
------------------------------	---------



# FLOOR CONSOLE CABINETS

## MI-12463 AND MI-12464

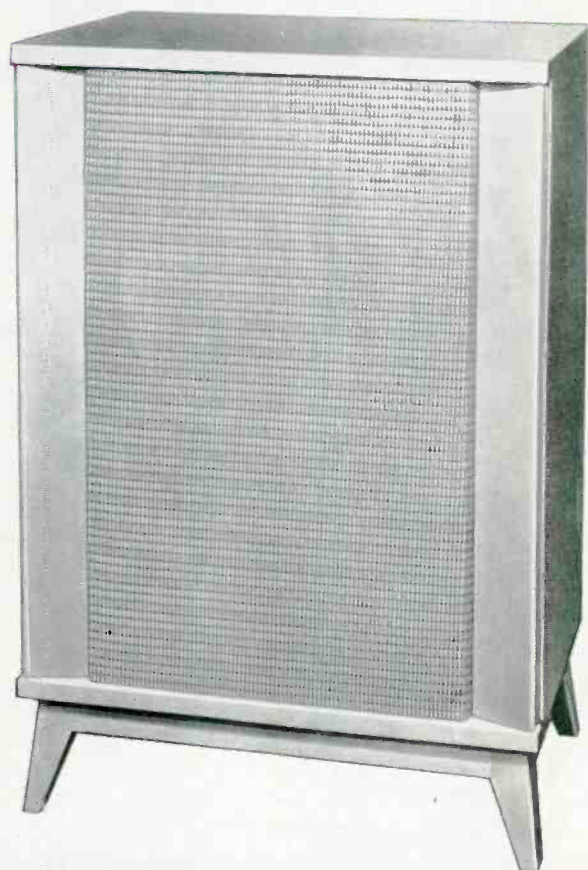

### FEATURES

- Maximum response at low frequencies
- Finishes and styling to blend with any surroundings
- Versatile cabinet design permits mounting cabinet either vertically or horizontally
- Designed specifically to complement LC-1A Speaker Mechanism
- Diagonally placed damping material absorbs cabinet resonance

### USES

The MI-12463 and 12464 Floor Speaker Cabinets were designed by RCA acoustic engineers, in collaboration with one of the country's leading stylists, to house the LC-1A Duo-cone Speaker and the SL-12 or SL-123 Single-cone Speaker. The styling of these cabinets make them ideal for use in executive offices, reception rooms, sponsors' booths or any location that warrants a pleasing setting.

### DESCRIPTION

The cabinet is a bass reflex or phase inverter type. MI-12463-M and 12464-M are high luster, hand-rubbed mahogany finish cabinets with 6" matching legs. A blonde version of the MI-12464 model is available. The cabinets may be mounted on their legs in a vertical or horizontal position as shown.

### SPECIFICATIONS

Dimensions:	
For 15" Speaker (LC-1A)	32" x 25" x 16"
For 12" Speaker (SL-12 or SL-123)	32" x 25" x 12"
Matching Legs	6"
Weight	Approx. 50 lbs.
Stock Identification (Mahogany SL-12 or SL-123 Housing)	MI-12463-M
Stock Identification (Blonde LC-1A Housing)	MI-12464-B
Stock Identification (Mahogany LC-1A Housing)	MI-12464-M





# WALL SPEAKER HOUSING

MI-11406

## FEATURES

- Designed to accommodate LC-1A Duo-Cone Speaker mechanism
- Ideal for broadcast control room use
- Umber gray finish to harmonize with companion equipment
- Can be mounted for long or short "throw" as desired
- Bass port is provided

## USES

The MI-11406 Speaker Housing is designed for broadcast studio and station monitoring applications and is ideal for wall or ceiling installations. Designed specifically for housing the LC-1A, Duo-Cone Speaker mechanism, the cabinet may also be used in auditioning booths, hallways, and executive offices.

## DESCRIPTION

This housing is constructed of heavy plywood, provides good acoustical properties, and is designed for high-quality performance without any sacrifice of the "Olson" duo-cone speaker performance.

The size and shape of the speaker housing (at end view, a 30, 60, 90 degrees modified triangle) is particularly

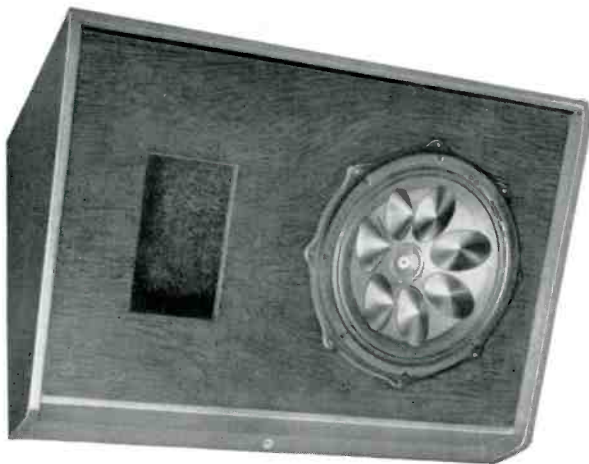

Front view of housing with grille cover removed to show LC-1A speaker mounting and bass port.

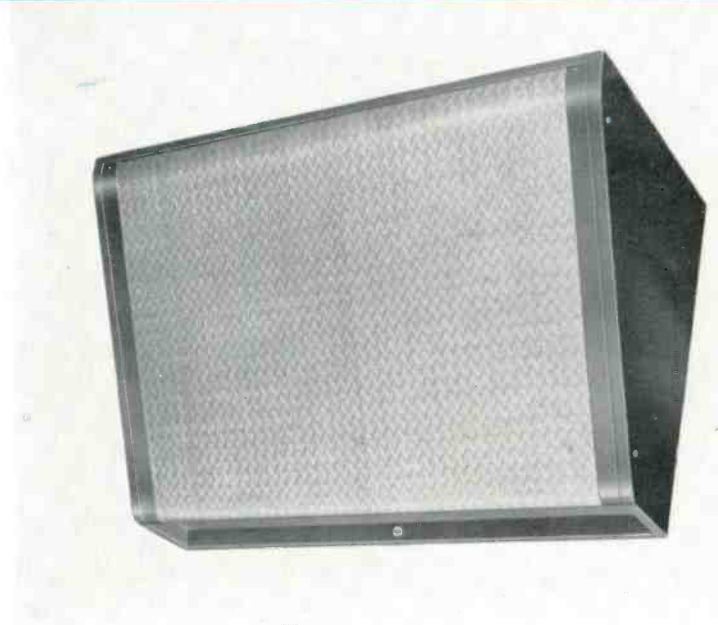

desirable for control room installations. It may be easily mounted to provide either a long or short "throw", as desired.

For best response, the housing is mounted so that both wall and ceiling form a part of the acoustical system. Thus, reinforcement from the ceiling may be utilized to raise the bass output and response at the low frequency end. A port is provided for increasing bass response and may be closed or opened, as required.

The overall speaker housing is approximately 17 $\frac{1}{8}$  x 21 $\frac{3}{4}$  x 37 $\frac{1}{2}$  inches with a sloping front which provides good sound radiation characteristics. The speaker mechanism and wiring are accessible through a removable grille which permits installation or servicing, without removing the cabinet from the wall.

The housing is finished in umber gray and has an attractive woven plastic grille. Its appearance matches the tone and styling of other studio equipment.

## SPECIFICATIONS

Dimensions (exterior):	
Length .....	37 $\frac{1}{2}$ "
Height .....	21 $\frac{3}{4}$ "
Depth .....	17 $\frac{1}{8}$ "
Weight .....	45 lbs.
Finish.....	Umber gray with woven plastic grille cloth
Stock Identification .....	MI-11406

# WALL SPEAKER HOUSING

MI-11407-A

## FEATURES

- Ideal for Station Control rooms, clients' booths, offices and studios
- In combination with MI-11408 Speaker, the Housing provides "Broadcast Quality" monitoring
- Styled to match companion RCA Broadcast Audio Equipment
- May be mounted for either 30° or 60° "throw" for long or short control rooms

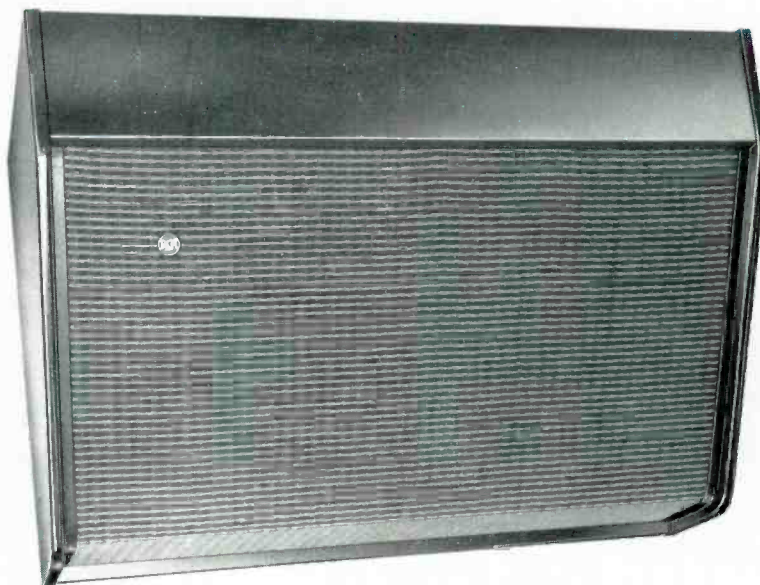

## USES

The MI-11407-A Wall Housing with its associated Speaker Mechanism is designed specifically to provide economical Broadcast Monitoring. Such applications include AM/FM and TV control rooms, clients' booths, offices and studios.

## DESCRIPTION

The MI-11407-A Housing is designed to house either 12-inch or 10-inch speaker mechanisms and projects sound downward at an angle of 30° or 60°. This permits mounting of the unit to provide either a long or short "throw". The housing is solidly constructed of 1/2-inch plywood with dark umber gray finish. The housing comes with an adaptor plate for 10-inch speakers, which may be removed when it is desired to house a 12-inch speaker mechanism. The grille is of plastic woven cloth and covers the entire front panel. The housing presents a neat, compact appearance and is of the smallest practical size commensurate with good performance.

## SPECIFICATIONS

Dimensions (exterior):	
Overall Height .....	16 <sup>3</sup> / <sub>16</sub> "
Overall Width .....	.25"
Overall Depth (front to back).....	11 <sup>1</sup> / <sub>2</sub> "
Volume.....	.2700 cu. in.
Approximate Weight (unpacked).....	12 lbs.
Finish.....	Dark umber gray
Stock Identification .....	MI-11407-A



MI-11408 Speaker Mechanism used in the above MI-11407-A Wall Housing.

## Accessories

12" Speaker Mechanism.....	MI-12418-B
10" Speaker Mechanism.....	MI-11408
Matching Transformer (4-8-15 ohms).....	MI-11731

# WALL SPEAKER HOUSING

## MI-13253

### FEATURES

- Acoustically treated interior
- Completely enclosed cabinet
- Attractive woven plastic grille cloth
- Handsome sloping front design
- Solid 1/2-inch wood sides
- Heavy vibration-free construction

### USES

The MI-13253 Wall Housing with a 12-inch speaker mechanism or a 10-inch speaker and reducing baffle (MI-13245-A) is suitable for use in many locations such as reception rooms, corridors, offices, dressing rooms, etc. It may also be used in a talk-back and cue system in studios.

### DESCRIPTION

The top, front and bottom of the Wall Speaker Housing, MI-13253, is one-piece walnut finish veneer. The sides are 1/2-inch solid wood. To insure extra strength, it is constructed with curved edges. The speaker opening is covered with two-tone grille cloth of woven plastic in a finish that matches the wood. The back of the unit is open and mounting brackets are furnished.

12-inch Speaker MI-12418-B which can be housed in the MI-13253 Wall Housing.

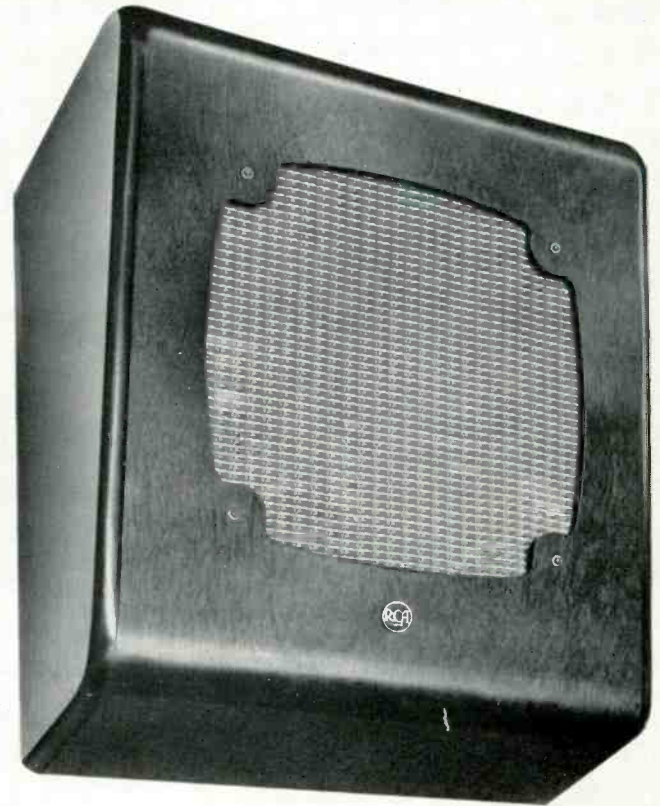

A reducing baffle, MI-13245-A, may be obtained which will adapt the MI-13253 housing to accommodate a 10-inch speaker mechanism such as the RCA MI-11408, or the MI-6333-D.

### SPECIFICATIONS

Dimensions (exterior):	
Height .....	16 1/2"
Width .....	14"
Depth .....	8 1/2" maximum
Weight .....	3 lbs., 10 oz.
Material .....	Wood
Finish .....	Walnut grained
Stock Identification:	
Wall Housing .....	MI-13253

### Accessories

Reducing Baffle to Mount 10" Speaker.....	MI-13245-A
12" Speaker Mechanism.....	MI-12458
12" Speaker Mechanism.....	MI-12418-B
12" Speaker Mechanism.....	MI-12654
10" Speaker Mechanism.....	MI-6333-D
10" Speaker Mechanism.....	MI-11408



# WALL SPEAKER HOUSING

MI-6104

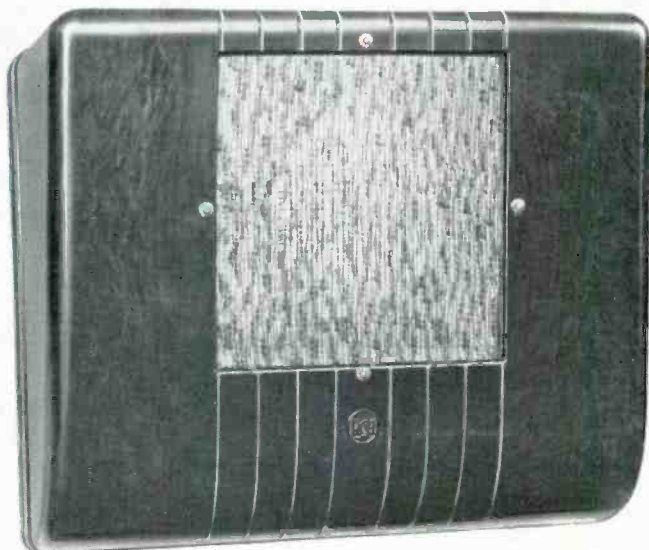

## FEATURES

- Made of fire resistant molded plastic
- Natural walnut grained finish
- Attractive modern design
- Matching two tone plastic grille cloth
- Sloping front for better coverage
- Sturdy construction—lifetime service
- Knockouts provided for volume control
- Can be painted to match walls

## USES

This molded plastic sloping front baffle will find many and varied uses. Its rich, walnut grained finish and pleasing lines make it especially attractive for use in studios, offices, corridors, small auditoriums, dressing rooms and numerous other places.

The RCA 8-Inch Speaker MI-12454 has a frequency response characteristic especially selected to give optimum performance and tonal balance when used in this baffle.

## DESCRIPTION

The MI-6104 baffle is molded of walnut grained fire resistant thermosetting plastic. It has four heavy reinforcing ribs on the inner surface which provide additional strength and rigidity and form a frame for the removable speaker insert. The face of the insert is covered with an attractive two-tone plastic grille cloth. It is held in place by four decorative head screws which also provide a secure mounting for a standard 8-inch speaker.

Two "knockouts" are provided, one on each side of the speaker opening, for installing a volume control and/or other control devices. A complete set of mounting hardware is also provided.

The housing has sufficient depth to permit the addition of a reducer sub-baffle for mounting speakers smaller than eight inches.

## SPECIFICATIONS

Standard Loudspeaker .....	8"
Material.....	Molded thermosetting plastic
Finish .....	Walnut grained
Dimensions:	
Width .....	15¼"
Height .....	12¼"
Depth (maximum) .....	5⅝"
Clearance (center of speaker).....	4"
Mounting.....	Two brackets and hardware (supplied)
Stock Identification .....	MI-6104

## Accessory

8" Speaker Mechanism.....	MI-12454
---------------------------	----------

# LINE MATCHING TRANSFORMERS

MI-12368, MI-12369, AND MI-11731



MI-12368

## DESCRIPTION

This transformer has separate primary and secondary windings on a 7/8" x 3/4" core. The primary is tapped with 10" color coded leads to permit matching to a number of different speaker line impedances. The secondary is tapped with 10" color coded leads to match voice coil impedances of 4, 8, or 16 ohms.

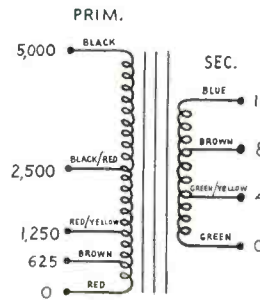

## SPECIFICATIONS

Frequency Response..... $\pm 1/2$  db from 60 to 10,000  
 Distortion.....2% max. from 100 to 10,000 @ 8 watts  
 Power Handling...Max. 16 watts of program material  
 Mounting Centers .....3 1/8"  
 Dimensions.....Height 2 1/4", Length 3 3/4", Width 2"  
 Net Weight.....1 lb. 6 oz.  
 Stock Identification .....MI-12368

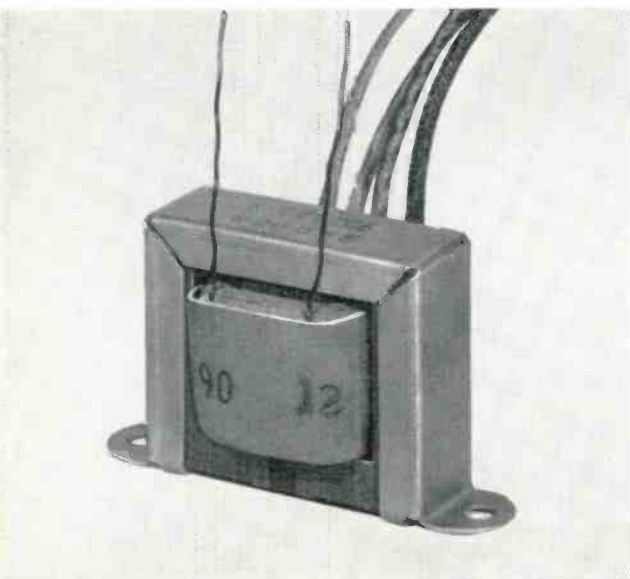

MI-12369

## DESCRIPTION

This transformer has separate primary and secondary windings on a 5/8" x 5/8" core. The primary winding is tapped with 10" color coded leads to match several different line impedances used in multiple speaker installations. The secondary matches any 3.2 to 4 ohm speaker

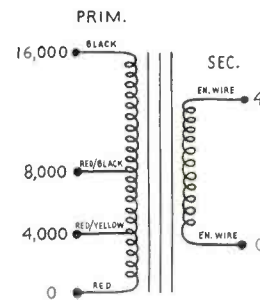

## SPECIFICATIONS

Frequency Response....1 db from 100 to 12,000 cycles  
 Distortion.....2% max. from 100 to 8,000 @ 5 watts  
 Power Handling.....Max. 8 watts program material  
 Mounting Centers .....2 3/8"  
 Dimensions.....Height 1 5/8", Length 2 13/16", Width 1 1/16"  
 Net Weight .....10 oz.  
 Stock Identification .....MI-12369

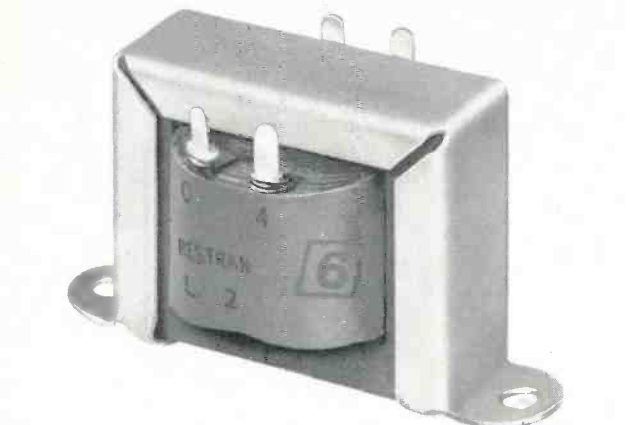

MI-11731

## DESCRIPTION

MI-11731 is a single-winding transformer used to match any combination of 4, 8 and 15 ohm speaker impedances. Soldering lugs are provided for making connections.

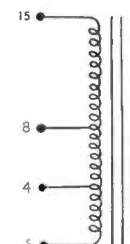

## SPECIFICATIONS

Frequency Response..... $\pm 1.0$  db from 60 to 10,000  
 Distortion.....2% max. from 100 to 10,000  
 Power Handling .....8 watts  
 Mounting Centers .....2 3/8"  
 Dimensions.....Height 1 21/32", Length, 2", Width 3/4"  
 Net Weight .....10 oz.  
 Stock Identification .....MI-11731

# INTERPHONE EQUIPMENT

## FEATURES

- Convenient intercom with studio personnel or remote line as desired
- Suitable for mounting to console, desk, or wall
- Designed to be compatible with RCA TV equipment
- Simple circuit with anti-side tone feature
- Regulated power supply

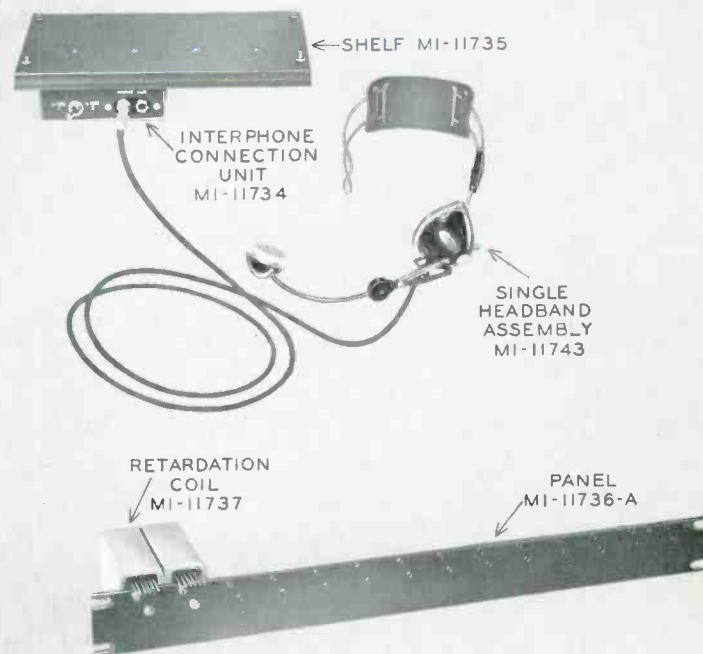

## USES

RCA Interphone Equipment is designed to provide convenient switching and headset connection facilities for an internal communication system. Such a system is particularly useful for the radio or television broadcast studio since it allows talking and listening with selected personnel

and with a conference bus or remote private line as desired. Any number of interphone connections may be used. The 24-volt d-c regulated power supply provides interphone power for a system using up to 30 headsets simultaneously.

## DESCRIPTION

Heart of the Studio Interphone System is the Interphone Connection Unit, MI-11734, which consists of a compact jack box designed for plate mounting. The unit consists of a simple circuit having an induction coil and capacitor to provide an anti-side tone feature. This results in local sounds being partially cancelled in the local earpiece. The circuit is housed in a small metal box having two phone jacks for use either with a single or a double headset as required, and a two-position toggle switch for selecting a local circuit or a remote line. A cable plug is mounted in the rear.

A Retardation Coil, MI-11737, permits simultaneous use of four carbon microphones such as one interphone connec-

tion unit and three camera headsets on a common battery or power supply. The coil permits a d-c power voltage to be imposed upon the two-wire telephone talking line. This audio frequency choke minimizes the effect of the power supply from lowering the two-wire telephone impedance at voice frequencies, and also allows adequate flow of direct current.

Mounting Panel, MI-11736-A, will permit mounting up to 14 retardation coils in the rack. Either a Single Headband Assembly, MI-11743, or a Double Headband Assembly, MI-11744, can be used for listening and talking with the Studio Interphone System.



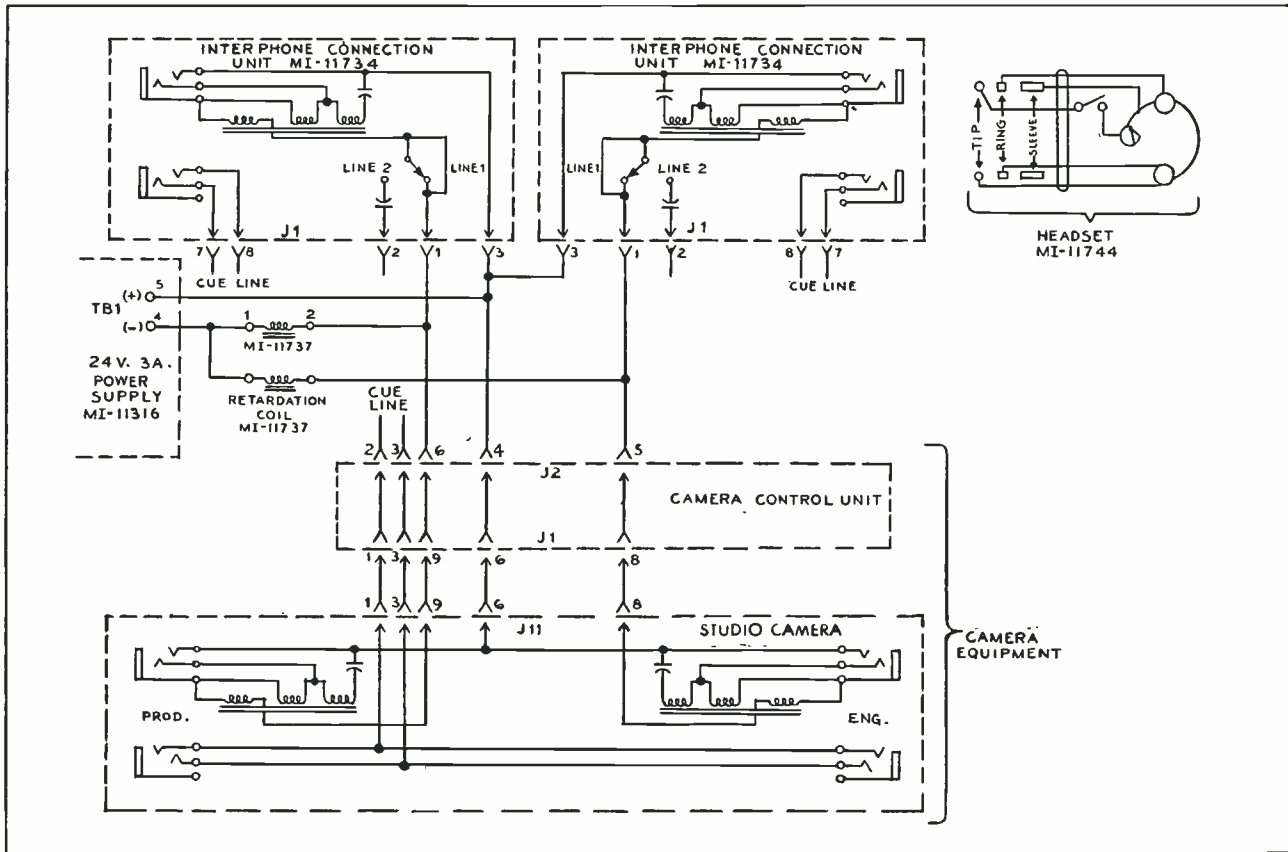

**SPECIFICATIONS**

- D-C Resistance (Headset):  
 Microphone Switch On.....70 ohms approximately  
 Microphone Switch Off .....Infinite
- Inductance at 1000 Cycles (Headset):  
 Microphone Switch On.....70 millihenries approximately  
 Microphone Switch Off .....245 millihenries
- D-C Resistance (Retardation Coil).....165 ohms  
 Inductance (Retardation Coil).....3.4 henries  
 Maximum Recommended Load Current.....125 ma d-c  
 Power Supply.....Regulated 24 volts, 3 amps, d-c
- Dimensions:  
 Interphone Connection Unit.....4<sup>5</sup>/<sub>8</sub>" x 4<sup>1</sup>/<sub>4</sub>" x 2<sup>3</sup>/<sub>16</sub>"  
 Retardation Coil.....4<sup>5</sup>/<sub>8</sub>" x 1 45/64" x 1<sup>3</sup>/<sub>16</sub>"  
 Mounting Plate.....11" x 6<sup>3</sup>/<sub>8</sub>"  
 Retardation Coil Panel, MI-11736.....19" x 13<sup>3</sup>/<sub>4</sub>" x 3<sup>1</sup>/<sub>16</sub>"  
 Retardation Coil Panel, MI-11736-A.....19" x 13<sup>3</sup>/<sub>4</sub>" x 3<sup>1</sup>/<sub>16</sub>"  
 Regulated Power Supply.....9" x 7<sup>3</sup>/<sub>4</sub>" x 5<sup>3</sup>/<sub>4</sub>"
- Weight:  
 Interphone Connection Unit.....1 lb., 11 ozs.  
 Retardation Coil .....15 ozs.  
 Retardation Coil Panel, MI-11736.....19 ozs.  
 Retardation Coil Panel, MI-11736-A.....18 ozs.  
 Single Headband Assembly.....6 ozs. (less cord)  
 Double Headband Assembly.....9 ozs. (less cord)  
 Regulated Power Supply.....25 lbs. (net)

**Stock Identification of Interphone Components:**

Interphone Connection Unit.....	MI-11734
Retardation Coil .....	MI-11737
Shelf for Mounting MI-11734.....	MI-11735
Panel (Accommodating 14 Retardation Coils).....	MI-11736-A
Single Headband Assembly.....	MI-11743
Double Headband Assembly.....	MI-11744
Regulated Power Supply.....	MI-11316

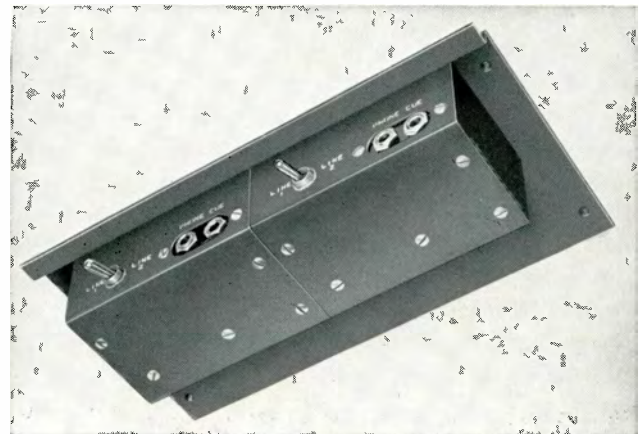

Console Shelf, MI-11735, has mounting accommodations for two Interphone Connection Units.

# FEATHERWEIGHT HEADSETS

## MI-11749 AND 11750

### FEATURES

- Extremely lightweight—smooth, comfortable fit—can be worn for extended periods of time without fatigue
- High sensitivity
- Sturdy bakelite shells and caps
- Six-foot water-resistant cord
- Concealed terminals
- Choice of single or double ear-phones



### USES

The MI-11749 and 11750 Featherweight Headsets are extremely lightweight offering the utmost wearing comfort for those engaged in control room monitoring, remote pickups, and other broadcast applications requiring headphone use. Both Single Headset, MI-11749, or Double Headset, MI-11750, are high quality units of durable molded black plastic, attractive in appearance, sensitive in response, and for use.

### DESCRIPTION

The Featherweight Single Headset, MI-11749, consists of a single durable molded black plastic earphone, 2 1/4" in diameter attached to a 1/4" wide stainless spring steel headband adjustable for optimum wearing comfort. The phone has concealed terminals and is extremely sensitive, equaling in clarity and volume most double headsets. The headset has a d-c resistance of 2000 ohms and impedance of 9000 ohms. The unit weighs approximately 2 ounces.

The Double Headset, MI-11750, weighs only 4 1/2 ounces, and consists of double earphones identical to those of the single headset, mounted by spring adjustments to a double fabric covered double wire band headband. The unit has a d-c resistance of 5000 ohms and an impedance of 24,000 ohms.

Both headsets are fitted with a 6 foot water-resistant cord with a popular phone style plug. The bakelite body is practically non-breakable. The plug is 2 7/8" long overall, with 1 1/2" prong, 1/4" in diameter which fits all standard jacks. The cord pin tips are held by set screws.

### SPECIFICATIONS

	Single Earphone	Double Earphone
D-C Resistance .....	2,000 ohms	5,000 ohms
Impedance .....	9,000 ohms	24,000 ohms
Earphones .....	2 1/4" dia.	2 1/4" dia.
Terminals .....	Concealed	Concealed
Plug .....	Standard 1/4" jack	Standard 1/4" jack
Weight .....	2 ozs.	4 1/2 ozs.
Stock Identification .....	MI-11749	MI-11750



# MULTI-COM INTERCOMMUNICATION EQUIPMENT



## FEATURES

- Excellent speech reproduction
- Compact, attractively styled cabinets
- Low power consumption
- Underwriters' Laboratories approved
- Easily installed
- Many models available to handle varied intercom needs
- Systems readily changed, rearranged, or expanded

## DESCRIPTION

RCA Multi-Com equipment consists of master instruments and remote units. The master unit contains a combination loudspeaker-microphone; volume control; talk-listen switch; and station selector keys for calling other instruments. A pilot light on the master indicates when the instrument is turned on. Single remote Multi-Com units contain a loudspeaker-microphone and switch for calling one master instrument. Six-key Remotes contain a loudspeaker-microphone and switches for calling five master units.

Multi-Com Master equipment is compact and handsomely styled to compliment any office decor. Cabinets provided are of hand-rubbed walnut finish.

RCA Multi-Com master instruments with 6, 12, 24, and 48 keys are available in both annunciator and non-annunciator series. Please refer to Table 1 for station capacities. The annunciator series visually identifies and records each incoming call received. The equipment is

## APPLICATION

RCA Multi-Com is a new electronic intercommunication system which provides instant two-way voice communication. Its application covers all segments of industry, commerce, and institutions. Multi-Com can be effectively and economically applied wherever walls and distance separate individuals who must communicate.

easily installed, simple to operate, and requires little maintenance. It features excellent speech characteristics and reproduction quality, permitting the user to talk in normal, conversational tones.

## SYSTEMS

RCA Multi-Com has been designed to offer the high degree of flexibility required to meet a complete range of intercom functions and requirements. A complete system may consist:

- 1) Entirely of master instruments.
- 2) Of one master instrument and one or more remote units.
- 3) Of a combination of a number of master instruments, each with one or more remote or multiple remote units.

Master instruments can be wired for either confidential or non-confidential operation. Eavesdropping is possible in a non-confidential arrangement but not with the confidential circuit.



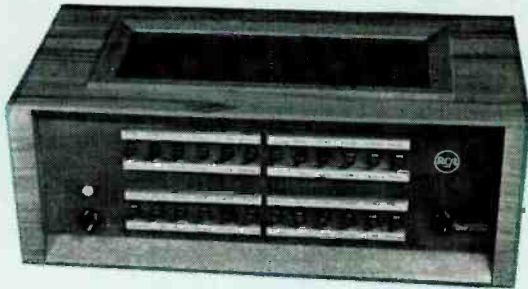

### MULTI-COM NON-ANNUNCIATOR MASTERS

Master units of the non-annunciator series are equipped with a combination on-off switch and volume control; a pilot light; one or more panels of selector keys, and a talk-listen switch. The talk-listen switch has three positions: standby, listen, and talk. The last selector key on the panel is a CALL-IN switch. When another instrument calls a non-annunciator master, the master answers by flipping up the CALL-IN switch and depressing his talk-listen switch. When the caller is identified, the master flips up the proper station key and returns the CALL-IN key to neutral position. The conversation proceeds, using only the talk-listen switch. For MI stock identification numbers and system capacities, refer to Table 1.

### MULTI-COM ANNUNCIATOR MASTERS

These masters have the same basic features of the non-annunciator masters described above. In addition, these units are equipped with annunciator buttons which are located above the selector keys. The annunciators are of the positive action type, are easily reset, and provide visual identification of incoming calls. Only one annunciator wire is required for each instrument connected. Annunciators have non-interfering d-c coils. When one station calls another, the annunciator button identifying the caller pops out at the station receiving the call and a buzzer sounds. This identifies the caller and also provides a record of all calls received while a station is unattended. For MI stock identification numbers and system capacities, please refer to Table 1.

### MULTI-COM ANNUNCIATOR SPECIAL MASTERS FOR REMOTE UNITS ONLY

Annunciator Special Masters series for use with remote units only are specified where it is desirable for an executive to contact several staff members who need not communicate with each other. When remote units call the master instrument, the annunciator above the proper station selector key pops out and a buzzer sounds. The master resets the annunciator, flips up the correct station key and uses his talk-listen key to control the conversation. The remote unit does not have any control to operate. For MI stock identification numbers and system capacities, please refer to Table 1.



**MULTI-COM REMOTE INSTRUMENTS**

**MI-14758 Multiple Remote Unit**

This useful, compact unit mounts flat on the desk, occupies little space, and presents a neat appearance. It is constructed of durable two-tone plastic. The MI-14758 can contact master instruments only. It has a 5-master station capacity.



**MI-14759**

Operation and functions of this single remote unit are the same as for the MI-14775 deluxe remote unit, however, it is constructed of durable two-tone plastic. Used with all types of master instruments.



**MI-14775**

This attractive deluxe remote unit is finished in hand-rubbed walnut and has the same distinctive bronze grille used on master instruments. It has one control—a CALL-IN key. Since the master instrument controls the conversation through the talk-listen key, personnel at remote installations have both hands free while conversing and can write, hold a phone, or move about. Used with all types of master instruments.



**Table 1 — IDENTIFICATION AND FUNCTIONS OF RCA MULTI-COM INSTRUMENTS**

RCA Stock Identification Number	System Capacity	Functional Features
<b>MULTI-COM NON-ANNUNCIATOR MASTERS</b>		
MI-14760	6	Can be connected for private or non-private operation. Have facilities for both masters and remotes. Have buzzer which sounds on all incoming calls. Equipped with CALL-IN switch for use with remotes.
MI-14761	12	
MI-14762	24	
MI-14763	48	
<b>MULTI-COM ANNUNCIATOR MASTERS</b>		
MI-14767	7	Have all features of Non-Annunciator Masters except CALL-IN switch. When other masters or remotes call, buzzer sounds and annunciator button indicates station calling. MI-14767 and 68 have third position (non-locking) on each selector key for calling other masters. MI-14769 and 77 have common key which calls any station whose selector key is closed.
MI-14768	13	
MI-14769	23	
MI-14777	47	
<b>MULTI-COM ANNUNCIATOR SPECIAL MASTERS FOR REMOTE UNITS ONLY</b>		
MI-14764	7	Have facilities for remotes only. When remote calls, buzzer sounds and annunciator button indicates station calling.
MI-14765	13	
MI-14766	25	
MI-14776	49	
<b>MULTI-COM REMOTE UNITS</b>		
MI-14775	1	Deluxe walnut cabinet. May be used with any type of master. Single remote in two-tone plastic. May be used with any type of master. Multiple remote in two-tone plastic. Can communicate with masters only.
MI-14759	1	
MI-14758	5	

# MULTI-COM INTERCOMMUNICATION EQUIPMENT

## GENERAL SPECIFICATIONS

Capacities:	See Table 1 for specific system capacities.
Cabinets:	Carefully constructed walnut cabinets with smooth, hand-rubbed finish. Remote units available in two-tone plastic.
Power Requirements:	105-125 volts, 50-60 cycle a-c.
Tubes:	6AQ5, 6AU6, 6X4.
Circuits:	50 ohm balanced line. Provision for confidential or non-confidential circuit connection as desired. Uses standard 22 AWG master conductor cable.
Talk-listen Switch:	Rugged three position switch. Positions are 1) standby, 2) listen, 3) talk. Pure silver switch contacts. Silver plated phosphor bronze leaf springs.
Speaker:	Four-inch speaker, 1.47 oz. permanent magnet. 50 ohm voice coil impedance.
Adjustable Volume Control:	Combined with on-off switch. Pilot light indicates when master unit is turned on.
Junction Box:	Equipped with junction box with large, convenient terminal board for quick, easy installation. Junction box supplied with 6 feet of flexible cable.
Dimensions: (overall)	6, 12 and 24 key models, 15½" long, 7⅞" deep, 3⅞" high. 48 station models 15½" long, 7⅞" deep, 6" high. Single Remote units, 8⅞" long, 3½" deep, 5¾" high. Multiple Remote, 8" long, 6⅝" deep, 3⅞" high. Deluxe Remote, 7¼" long, 7⅞" deep, 3⅞" high.
Shipping Weights:	6-Key—16 lbs.; 12-Key—17 lbs.; 24-Key—18 lbs.; 48-Key—21 lbs. 1-Key Remote—3 lbs.; 6-Key Remote—4 lbs. Deluxe Remote—6 lbs.
Power Drain:	Does not exceed 13 watts in idle position; 29 watts in listen position; and 29 watts in talk position.
Underwriters' Laboratories:	UL approved wiring.



# DISTORTION AND NOISE METER

## TYPE WM-71A

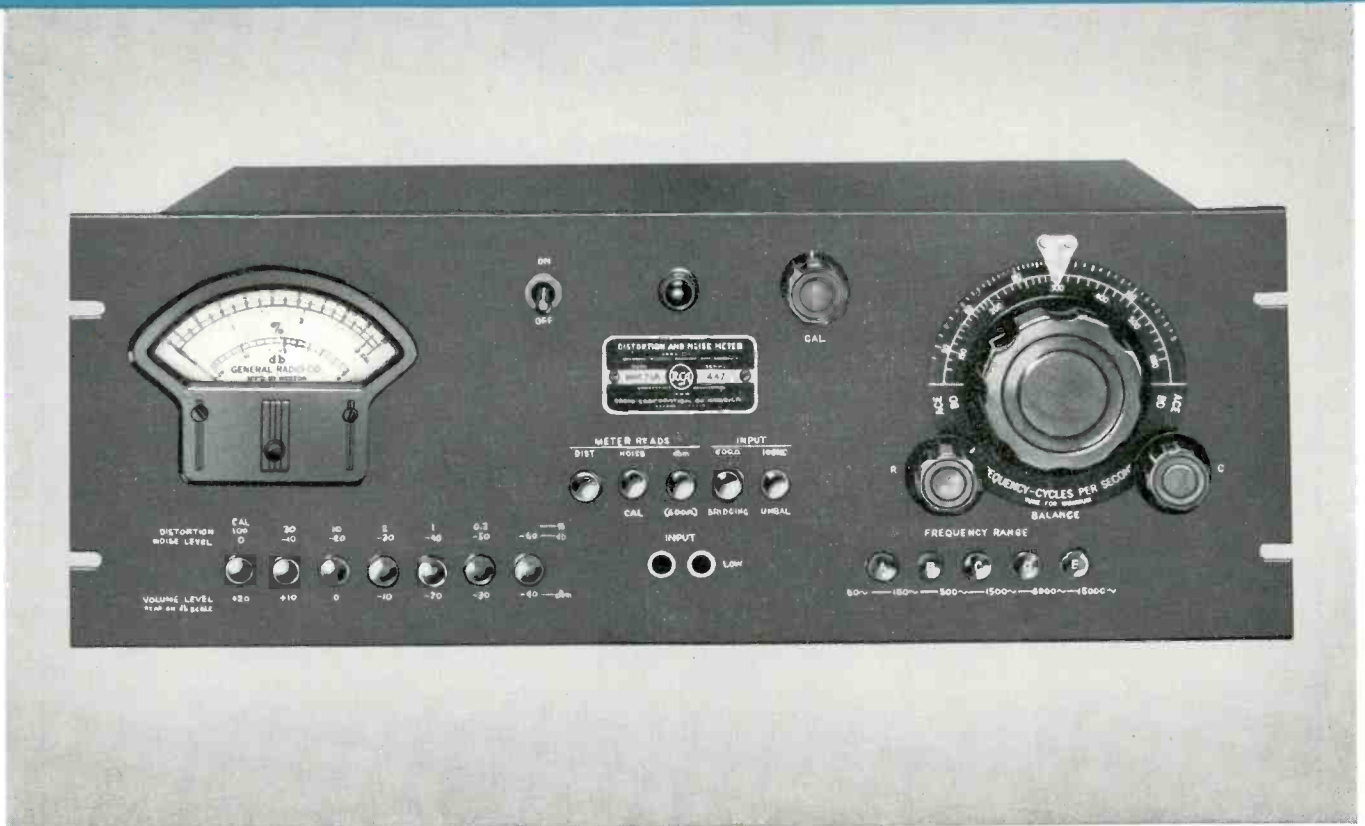

### FEATURES

- Quick frequency selection
- Can be used as a wide range highly sensitive voltmeter or VU meter
- Distortion measurements, as low as 0.1%, quickly and easily made by one tuning adjustment
- Requires no direct connection to audio oscillator
- Audio oscillator distortion can be measured
- Tapped power transformer permits operation on either 105-125 volts or 210-250 volts
- Audio frequency range 50 to 15,000 cycles for distortion measurements; 30 to 45,000 cycles for noise and hum measurements

### USES

Distortion and Noise Meter, RCA Type WM-71A, is a compact precision instrument for measuring the total distortion and the level of noise and hum in audio-frequency circuits. It permits continuous coverage of the audio frequency range, indicating directly the percentage of a-f distortion in modulators, speech amplifiers, a-f generators, receivers and other equipment employing audio frequencies. The instrument will give full-scale readings for distortion percentages as low as 0.3%, and is capable of measuring noise components at frequencies from 30 to 45,000 cycles.

The instrument has many uses in the communications laboratory and in the production testing of radio receivers as a wide-range, highly sensitive voltmeter for such measurements as signal-to-noise ratio, AVC characteristics and hum level. With the aid of an oscilloscope, individual hum and distortion components can be identified. When used with a linear detector such as the RCA Type BW-66E Amplitude-Modulation Monitor, the distortion and noise characteristics of broadcast and other radio-telephone transmitters can be measured.

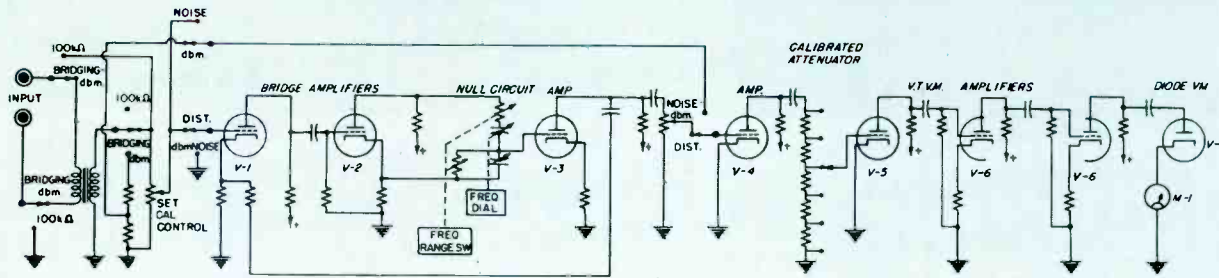

Elementary schematic circuit diagram of the WM-71A Distortion and Noise Meter.

**DESCRIPTION**

The WM-71A Distortion and Noise Meter consists essentially of a high-gain amplifier, an r-c interstage coupling unit, a calibrated attenuator for adjusting the sensitivity, and a panel meter to indicate amplifier output.

The r-c interstage coupling unit balances to a sharp null at the frequency to which it is tuned, the null frequency being continuously variable and controlled from the panel. Degeneration is employed to maintain high stability in the amplifier and to provide flat transmission characteristics except within an octave of the null point.

In measuring distortion the audio-frequency signal is applied to the instrument and the null point is obtained to balance out its fundamental frequency, leaving only its harmonics and other distortion components which are indicated in percentage directly on the panel meter. When the modulated output of a radio transmitter is to be measured, a linear rectifier is required to produce the audio envelope. Any linear detector system having an undistorted output of 1.5 volts can be used.

A switch on the front panel provides for switching out the null circuit so that the instrument can be used as an extremely sensitive voltmeter for measuring hum and noise levels. Since the WM-71A has only one tuning control plus a small trimmer, it can be quickly set to any frequency over its range. This is a time-saving feature in making a series of measurements. Two input circuits are provided: a transformer for bridging a 600-ohm line, and a direct connection to the 100,000-ohm gain control. Input terminals are provided at the rear of the instrument for direct connection to the modulation monitor.

The instrument is relay rack mounted. All essential controls are located on the front panel. A large meter with an easily read, illuminated scale is provided, and percentage, decibel and dbm calibrations are included. The power supply is voltage regulated so that line surges have no appreciable effect on the instrument.

**SPECIFICATIONS**

**Performance Specifications**

- Distortion Range..... Full scale deflections for 0.3%, 1%, 3%, 10% or 30% distortion
- Noise Measurement Range..... -80 db below reference calibration level, or 80 db below an audio-frequency signal of zero dbm level, at maximum sensitivity.
- Audio-Frequency Range..... 50 to 15,000 cycles (fundamental), for distortion measurements; 30 to 45,000 cycles for noise and hum measurements.
- Dbm Range..... Power-level range is from +20 to -60 dbm (0 dbm is one milliwatt in 600 ohms)
- Input Voltage Range..... 1.2 to 30 volts for the 100-kilohm input, and 0.8 to 30 volts for the 600-ohm bridging input
- Accuracy..... For distortion measurements ±5% of full scale for each range ± residual distortion as noted below; for noise and dbm measurements, ±5% of full scale.
- Residual Distortion Level:
  - 100-kilohm Input..... 0.05%, max., below 7500 c. 0.10%, max., above 7500 c.
  - Bridging Input..... 0.10%, max., between 50 and 7500 c. 0.05%, max., between 70 and 7500 c. 0.10%, max., above 7500 c.
- Residual Noise Level..... Less than -80 db
- Input Impedance..... 100,000 ohms unbalanced, and 600-ohm bridging input (10,000 ohms), balanced or unbalanced
- Power Line..... Tapped primary provides for operation on a-c line voltages of 105-125 volts, 50/60 cycles, single phase, or 210-250 volts, 50/60 cycles, single phase.
- Power Consumption..... 65 watts

**Tube Complement**

- 4-6J5
- 1-6H6
- 1-6SN7-GT
- 1-6X5-GT
- 1-6K6-GT
- 2-OD3/VR150

- Dimensions..... 19" wide, 7" high, 12" deep
- Weight ..... 37¾ lbs.
- Finish..... Umber gray lacquer

**Equipment Supplied**

- WM-71A Distortion and Noise Meter..... MI-30071-A
- Including electron tubes, line connector, interconnecting cable, instruction book (IB-4071-1), and spare fuses.

**Optional and Accessory Equipment**

- WA-28A Low Distortion Oscillator..... MI-30028
- BI-11A Transmission Measuring Set..... MI-11350

# AUDIO PUSH-BUTTON OSCILLATOR

## TYPE WA-28A



### FEATURES

- Very low distortion
- A high degree of frequency stability which makes this oscillator particularly adaptable for use with distortion meters employing r-c null networks
- Push-button selection of any one of 27 frequencies from 20 to 15,000 cycles
- Any other desired frequency within the normal range can be obtained by the use of plug-in resistors
- Duplicate output terminals on rear for relay-rack installation
- Chassis designed for mounting in standard equipment racks
- Ease of operation from front panel controls

### USES

The Type WA-28A Oscillator was designed particularly for use as a tone source for distortion measurements and as a power source for bridge measurements at audio frequencies. It is also satisfactory for use as a general-purpose laboratory oscillator.

The output frequencies include those recommended by the FCC for distortion measurements on broadcast transmitters. This oscillator is thus ideal for use with the Type WM-71-A Distortion and Noise Meter for rapid distortion measurements. The unusually pure waveform delivered by this oscillator at low frequencies makes distortion measurements possible at low frequencies.

### DESCRIPTION

The WA-28A oscillator is of the resistance-capacitance type and uses an inverse feedback. Separate feedback networks control the frequency and amplitude independently, thus providing high stability and low distortion. The degenerative feedback which controls the frequency is obtained by means of a parallel-T network including mica capacitors and wire-wound resistors. The regenerative network includes an automatic control system whereby a high



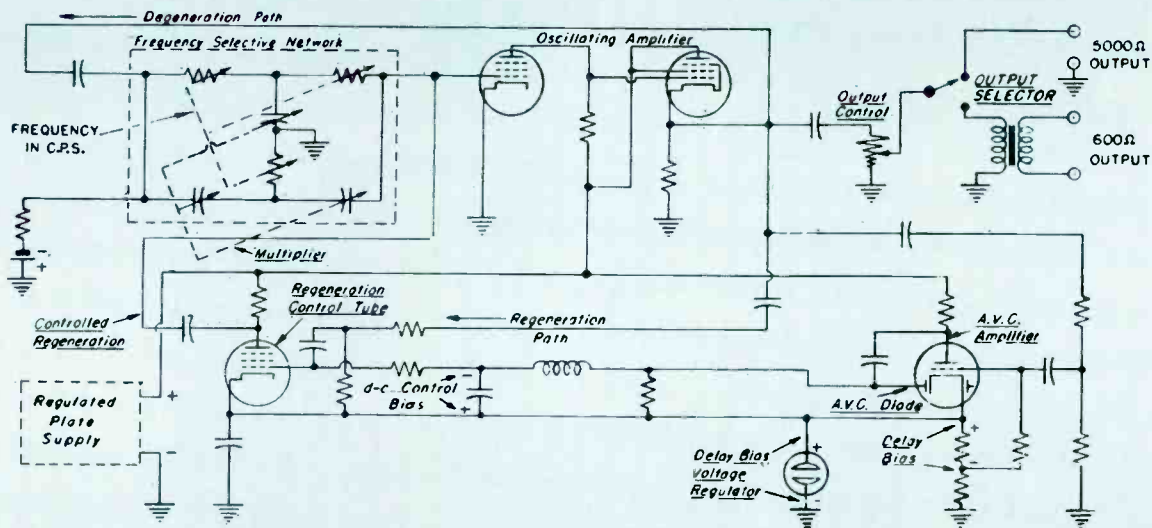

Elementary schematic circuit diagram of the WA-28A Low Distortion Oscillator.

degree of stability is obtained together with low harmonic distortion, without requiring any manual feedback adjustments.

The instrument is mounted on a chassis fitting standard equipment racks. Controls on the front panel include ten frequency push-button switches. Three other push-buttons select the output impedance and a control is provided for adjusting the output voltage. Three frequency multiplier switches and two output jacks are also provided. Terminals are located inside the instrument which permit any specific frequency between the limits of 20 and 15,000 cycles to be obtained by insertion of a set of three calibrated resistors. The values of these resistors for any frequency may be obtained from the chart.

The output impedances available are: a constant 600-ohms balanced to ground, a 600-ohms unbalanced, and a 5000-ohm unbalanced. The 600-ohm output positions use transformer coupling and therefore can be operated either into a balanced line or a grounded line. The internal impedance is essentially constant at 600 ohms. The 5000-ohm output position can be operated unbalanced only. The output control is a potentiometer, and consequently the output impedance is not constant. The total harmonic distortion of any of the outputs will not exceed 0.1% of 1% when operating between 40 and 7500 cycles, and is never more than 0.25% when operating at extreme frequencies. The operation of the instrument is substantially independent of climatic changes in temperature and humidity.

Jack-top binding posts with standard 3/4-inch spacing and standard Western Electric double output jack are provided on the panel. A ground terminal is also provided. A standard multipoint connector provides duplicate output terminals on the rear of the instrument for relay-rack

installation. These terminals are disconnected when a plug is inserted in the Western Electric-type panel jack. The instrument is provided with power cord, multipoint connector and spare fuses.

## SPECIFICATIONS

### Performance Specifications

Frequency Range.....	27 fixed frequencies between 20 and 15,000 cycles
Frequency Calibration.....	Adjusted within 1 1/2% ±0.1 cycle
Frequency Stability.....	Less than 0.02% frequency drift per hour after the first 10 minutes of operation
Output Power.....	18 milliwatts into 600 ohms load, or 6.6 volts open circuit; 100 milliwatts into 5000 ohm load, or 30 volts open circuit; constant within ±1 db throughout frequency range.
Output Impedances.....	600-ohm balanced to ground 600-ohm unbalanced 5000-ohm unbalanced
Waveform Distortion:	
5000-ohm Output.....	Less than 0.1% between 40 and 7500 cycles Less than 0.15% at other frequencies
600-ohm Output.....	Less than 0.1% between 40 and 7500 cycles Less than 0.25% between 20 and 40 cycles Less than 0.15% above 7500 cycles
Power Supply.....	105 to 125 (or 210 to 250) volts, 50/60 cycles, single phase
Power Consumption.....	45 watts

### Tube Complement

1—6Y6-G	1—6SJ7	1—6SK7
1—NE-17	1—6SQ7	1—6X5
1—6B4-G	1—6SL7-GT	1—OD3/VR150

Dimensions.....	19" wide, 7" high, 12" deep
Weight.....	32 1/2 lbs.
Finish.....	Light umber gray

### Equipment Supplied

WA-28A Low-Distortion Oscillator, complete.....	MI-30028-A
Including electron tubes, line connector, multiple point connector, instruction book (IB-4028-1) and spare fuses.	

### Optional and Accessory Equipment

Noise and Distortion Meter, Type WM-71A.....	MI-30071-A
Transmission Measuring Set.....	MI-11350

# TRANSMISSION MEASURING SET

TYPE BI-11A

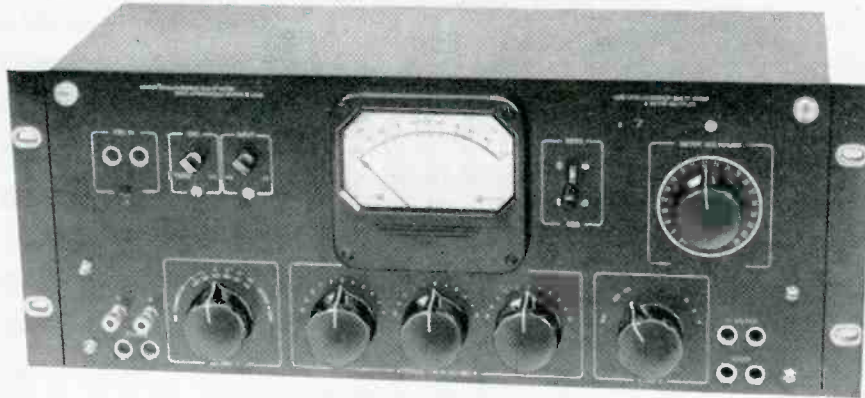

## FEATURES

- Simplifies measurement of transmission characteristics of audio systems and their components
- Eliminates lengthy calculations—direct reading
- $\pm 0.1$  db accuracy over frequency range of 20 to 20,000 cycles
- Automatic correction for changes in load impedance
- Output impedance switch for matching
- Wide range of load levels handled
- Hinged panel permits easy access to all components

## USES

The Transmission Measuring Set, Type BI-11A, is a simplified, accurate and direct-reading instrument designed for use in the following applications: (1) audio gain measurements; (2) audio loss measurements; (3) measurements of matching and bridging devices; (4) complex circuit measurements; (5) measuring mismatch loss and frequency response measurements. The instrument also may be used as an independent volume level indicator.

The instrument facilitates overall system measurements and may be used with the WA-28A Low Distortion Push-button Oscillator and the WM-71A Distortion and Noise Meter. It eliminates lengthy calculations and intricate setups. It is designed to provide accuracies conforming to FCC regulations and is particularly useful for broadcast stations in the master control room or at the transmitter.

## DESCRIPTION

The BI-11A Transmission Measuring Set consists of a volume indicator meter, input and output attenuators, an impedance matching system and jacks for convenient connections. A meter multiplier, which is geared to the load impedance shaft, provides an automatic correction for changes in load impedance. Convenient switches allow the volume indicator to be connected to the input of the attenuator system or to jacks for external connection. An

output impedance switch allows matching to 600-250-150-16-8-4 ohm circuits.

Level controls, switches, jacks and VI meter are located on the front of a standard 19 inch rack-type panel. The panel hinges forward to provide ready access to attenuators, jacks, switches and other components. Unit type assemblies (individual sections, such as source, attenuation and load) are readily removable for servicing. Each section is a complete assembly with its own jacks and terminal block.

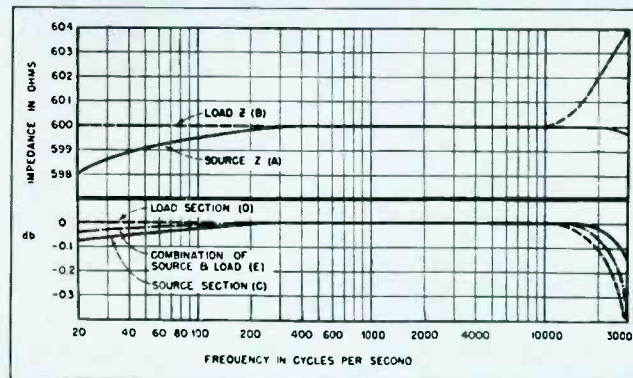

## SPECIFICATIONS

### Performance Specifications

Frequency Range.....	20 to 20,000 cycles
Accuracy (independent of level from +4 to -110 dbm):	
Overall.....	±0.1 db, 20 cycles to 20 kilocycles
Source and Load Impedances for Dial Indicators	
Over Entire Range.....	Within ±2%
Network Resistors .....	±1.0%

### Performance Specifications (Continued)

Source Characteristics:	
Shielded Output can be used equally well on either balanced or unbalanced equipment	
Ranges (in steps of 0.1 db).....	+4 to -110 db -10 to -124 db
Range of Impedance:	
Internally Terminated .....	600-150 ohms
Unterminated .....	600-250-150-30 ohms
Internal isolation network for operating into non-linear devices.	

### Load Characteristics (resistive load, ungrounded):

Range of Load Levels.....	+4 to +42 VU @ 600 ohms
Range of Impedance.....	600-250-150-16-8-4 ohms
Dimensions.....	19" wide, 7" high, 8 1/4" deep
Weight .....	19 lbs.
Finish.....	Light umber gray

### Equipment Supplied

Type BI-11A Transmission Measuring Set, complete.....	MI-11350
---	----------

### Optional and Accessory Equipment

Low Distortion Push Button Oscillator.....	MI-30028-A
Distortion and Noise Meter.....	MI-30071-A



# RECOMMENDED WIRING PRACTICES

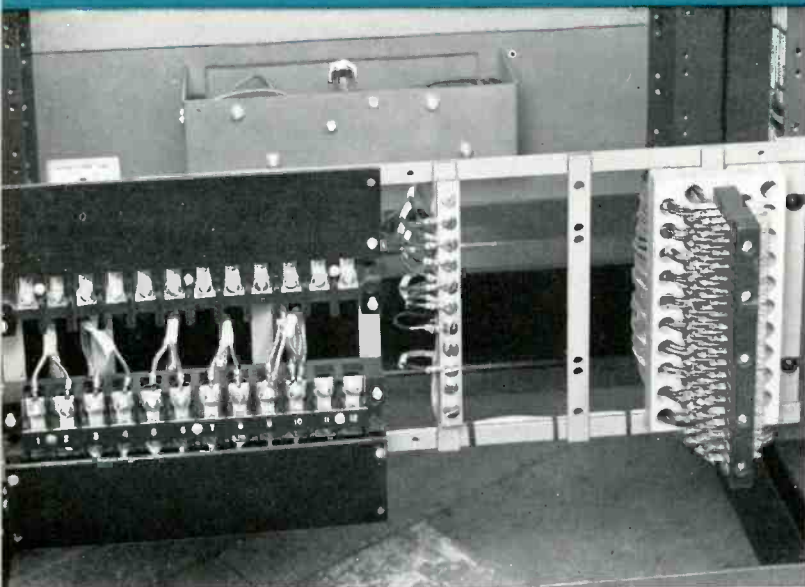

Fig. 1. Photo of terminals at bottom of rack. Power terminals are at left, ground buss in center and audio terminals at right.

Almost every studio undergoes minor modifications from time to time, and the subject of proper wiring practice is raised. Modern standards require careful elimination of noise and crosstalk from the program circuits. It is not uncommon to spend many hours wiring in new components, only to find their performance reduced by the wiring itself. A tested and proven standard practice can avoid much wasted time.

There are two basic philosophies employed in practical approaches to the noise problem. In one system every circuit shield is carefully isolated from its neighbors and grounded at one point only. In the other, all the shields of one unit (such as a rack) are put in such close contact that a brute-force ground is provided for any stray currents that might be present. This latter approach is taken in RCA equipment with modifications as follows:

Every rack, cabinet or desk is wired as a unit to terminal boards. The terminal boards are placed as near as possible, consistent with accessibility, to the point where the external circuits enter the unit. See Figs. 1 and 2 for examples.

In a rack, as viewed from the back, all audio cables are run on the right side of the rack; and all signal, a-c and d-c power cables are run on the left side. All audio circuits are twisted pair conductors shielded with a tinned copper braid. Separate cables are formed for:

(a) Microphone outputs, preamplifier outputs and other audio circuits with levels below  $-20$  vu.

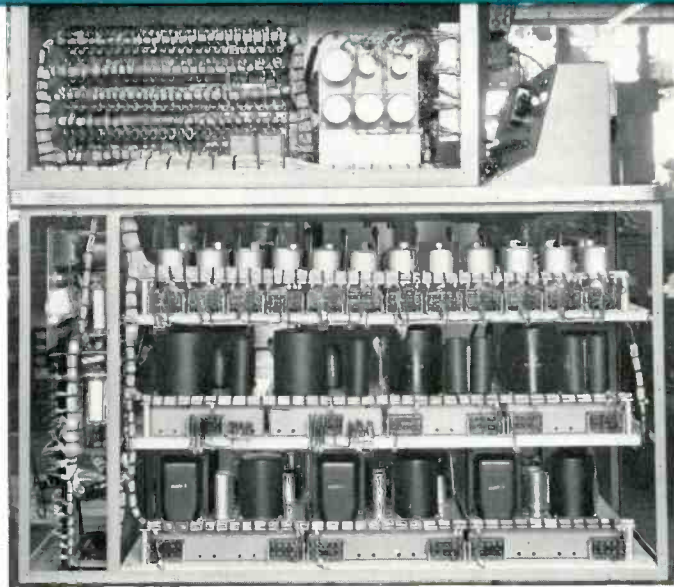

Fig. 2. View of wiring in a control desk. A-c circuits are below the shelves, and audio above.

- (b) Mixer, line and channel circuits up to  $+30$  vu.
- (c) Loudspeaker and other lines above  $+30$  vu.
- (d) At times further subdivisions are made for convenience in bulk or because levels are widely separated.

Each cable is bound with lacing cord so the shields are in tight contact for their entire length. Where two audio cables cross or join, they should either be definitely insulated or bound together. It is better to have tight contact than to risk an intermittent noise source made by casual contact.

The ends of the individual shields are terminated either with "wedge-on" collars or with plastic tape. The shields are grounded to a main ground bus near the terminal block. A shielded ground lead is run from each amplifier chassis to the ground bus.

The a-c and d-c power circuits are handled similarly. All a-c circuits should be in twisted pair, shielded cable. The a-c current should be balanced in each pair. That is, one pair should not be used for one side of a circuit and a second pair for the other side. If more than one pair is needed for the load, two or more pairs should be used with part of the load on each. Plus and minus plate potentials should be carried in single conductor shielded cable. Shields are tied off and grounded the same as the audio circuits.

Signal circuits do not require shielded wire. The frames of jacks should be tied together and grounded with a shielded wire the same as amplifier chassis.

In installing the equipment in a studio or control room the following rules have been found useful:

The pairs run in conduits should be grouped in the same general way as the cables in the racks. The audio conduits should be kept free from grounds to power conduits or power circuits. Low level audio circuits (less than -30 vu) should have the shields insulated from the conduits and from each other. Splices should be avoided. Low level conduits should be well spaced from power conduits.

Signal and telephone circuits should not be run in the same conduit with program or power circuits. Telephone leads should be twisted pair. Power and audio grounds should consist of separate, heavy shielded leads to the main station ground.

TV circuits in general should be considered high level circuits and should therefore be kept away from low level audio circuits. In particular, pulsed lamp circuits should be routed as far away from projector photocell and preamplifier circuits as possible. Shields should be insulated from ground and the audio circuit and shield grounded only at the point of lowest level.

Typical good practice for microphones is shown in Fig No. 3a. In this case two conductor shielded wire, with insulation over the shield, is used for the conduit run and the microphone cord. Fig. No. 3b shows somewhat better practice in which 3-conductor shielded, insulated cable is used for the conduit run and microphone cord. This latter practice removes any ground current from the shield.

Turntable pickup circuits should be handled like microphones with particular care being taken to keep the motor power circuits and their shields away from the audio circuits.

The input to mixer circuits is usually at comparatively high level, but the output is frequently very close to

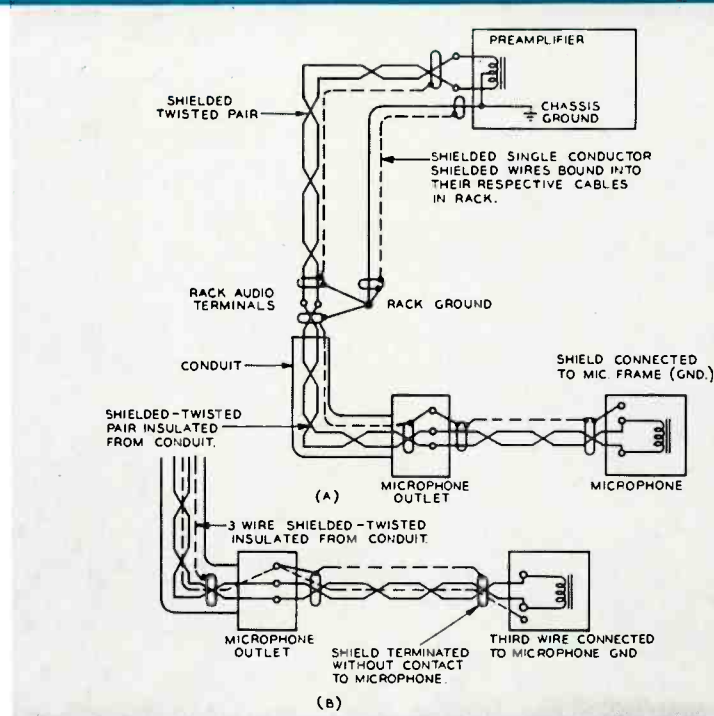

Fig. 3.

microphone level and the circuits should be treated in the same way. Fig. No. 4 shows typical good grounding practice in this respect. Unbalanced circuits may be used but are usually more difficult to handle if there is noise present. It will be noted that the only ground to this part of the system is at the point of lowest level and that all the circuits are balanced to ground. The center taps of the mixer attenuators are only tied to ground if special noise difficulty is encountered and tests indicate improvement. This occasionally happens on circuits which connect to remote lines or studio equipment with separate ground systems.

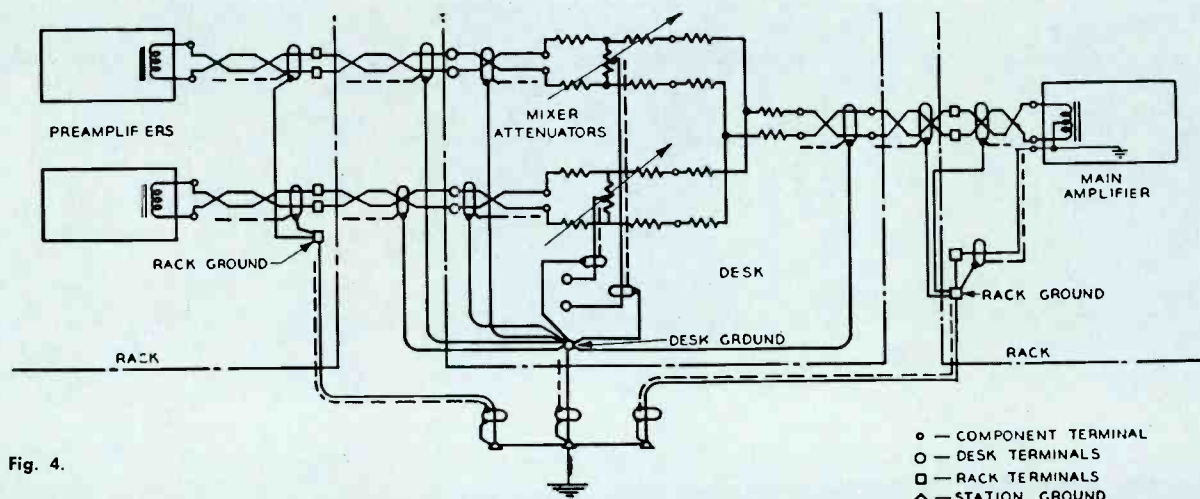
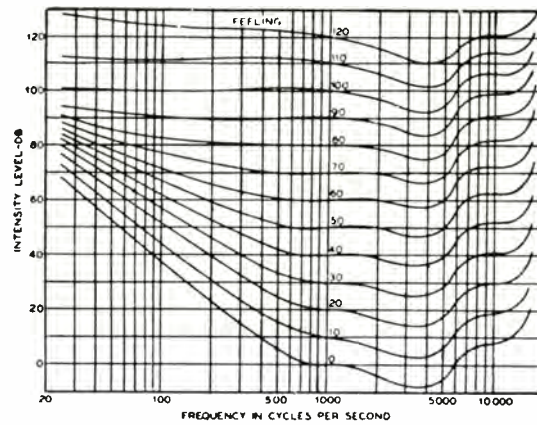

Fig. 4.

# AUDIO DATA SECTION

CONTOURS OF EQUAL LOUDNESS TO THE EAR



Loudness level contours.

Courtesy of the Acoustical Society of America



Impedance Loss, dB	600 Ohms		600 Ohms		600 Ohms		600 Ohms		600 Ohms		600 Ohms	
	R <sub>1</sub> Ohms	R <sub>2</sub> Ohms	R <sub>1</sub> Ohms	R <sub>2</sub> Ohms	R <sub>1</sub> Ohms	R <sub>2</sub> Ohms	R <sub>1</sub> Ohms	R <sub>2</sub> Ohms	R <sub>1</sub> Ohms	R <sub>2</sub> Ohms	R <sub>1</sub> Ohms	R <sub>2</sub> Ohms
0	∞	∞	∞	∞	∞	∞	∞	∞	∞	∞	∞	∞
0.1	50204	50204	0	100500	0	100500	0	100500	0	100500	0	50000
0.2	28280	28280	3.41	57380	6.85	57380	6.82	57380	7.2	57380	3.6	26086
0.3	17460	17460	5.16	34900	10.32	34900	6.82	34900	13.8	34900	6.9	17143
0.4	13068	13068	6.90	26100	13.80	26100	10.32	26100	21.0	26100	10.5	12766
0.5	10464	10464	8.60	20920	17.20	20920	13.79	20920	35.4	20920	14.1	10169
0.6	8640	8640	10.45	17230	20.85	17230	20.9	17230	43.2	17230	17.7	8333
0.7	7428	7428	12.1	14880	24.25	14880	24.2	14880	50.4	14880	21.6	7143
0.8	6540	6540	13.75	13100	27.53	13100	27.5	13100	57.6	13100	25.2	6250
0.9	5787	5787	15.51	11600	31.2	11600	31.02	11600	65.4	11600	28.8	5504
1.0	5208	5208	17.25	10440	34.3	10440	34.5	10440	73.2	10440	32.7	4918
1.5	3452	3452	25.9	6950	52.1	6950	51.8	6950	113.4	6950	36.6	3174
2.0	2582	2582	34.4	5232	69.7	5232	68.8	5232	155.4	5232	49.8	2316
2.5	2053	2053	42.9	4195	87.7	4195	85.9	4195	200.4	4195	56.7	1790
3.0	1703	1703	51.3	3505	106.2	3505	102.7	3505	247.8	3505	77.7	1452
3.5	1448	1448	59.6	3021	119.2	3021	119.2	3021	297.6	3021	100.2	1239.9
4.0	1249	1249	67.9	2651	143.8	2651	135.8	2651	351.0	2651	148.8	1209
4.5	1109	1109	76.1	2365	162.3	2365	152.2	2365	407.4	2365	175.5	1025
5.0	987.6	987.6	84.1	2141	182.3	2141	168.1	2141	466.8	2141	203.7	883.7
5.5	886.8	886.8	92.0	1956	203.0	1956	184.0	1956	530.4	1956	233.4	771.2
6.0	803.4	803.4	99.7	1807	223.8	1807	199.3	1807	597.0	1807	285.2	678.7
6.5	730.8	730.8	107.3	1679	246.3	1679	214.6	1679	667.8	1679	333.9	603.0
7.0	685.2	685.2	114.8	1569	268.5	1569	229.7	1569	743.4	1569	371.7	539.8
7.5	615.6	615.6	122.1	1475	292.4	1475	244.2	1475	822.6	1475	411.3	484.3
8.0	567.6	567.6	129.2	1393	317.1	1393	258.4	1393	907.2	1393	453.6	437.6
8.5	525.0	525.0	136.1	1322	342.8	1322	272.3	1322	996.6	1322	498.3	396.8
9.0	487.2	487.2	142.9	1260	369.4	1260	283.8	1260	1091	1260	545.3	361.2
9.5	453.0	453.0	149.5	1204	397.2	1204	298.9	1204	1191	1204	595.5	329.9
10.0	421.6	421.6	156.0	1154	427.0	1154	312.0	1154	1297	1154	648.5	302.2
11.0	367.4	367.4	168.1	1071	489.9	1071	336.1	1071	1529	1071	764.5	277.5
12.0	321.7	321.7	179.5	1002	539.5	1002	359.1	1002	1788	1002	894	255.5
13.0	282.8	282.8	190.3	946.1	596.3	946.1	380.5	946.1	2080	946.1	1040	231.3
14.0	249.4	249.4	200.2	899.1	636.3	899.1	400.4	899.1	2407	899.1	1204	201.3
15.0	220.4	220.4	209.4	859.6	681.6	859.6	418.8	859.6	2773	859.6	1496	173.1
16.0	195.1	195.1	217.9	826.0	721.5	826.0	435.8	826.0	3186	826.0	1731	149.6
17.0	172.9	172.9	225.7	797.3	757.7	797.3	451.5	797.3	3648	797.3	1987	129.8
18.0	152.5	152.5	234.4	772.8	793.3	772.8	465.8	772.8	4166	772.8	2275	113.0
19.0	136.4	136.4	239.5	751.7	816.0	751.7	479.0	751.7	4748	751.7	2574	98.68
20.0	121.2	121.2	245.2	733.3	846.1	733.3	490.4	733.3	5300	733.3	2874	86.4
22.0	95.9	95.9	255.9	703.6	891.1	703.6	511.7	703.6	6054	703.6	3277	75.8
24.0	76.0	76.0	264.4	680.8	923.2	680.8	528.8	680.8	6954	680.8	3700	66.66
26.0	60.3	60.3	271.4	663.4	963.4	663.4	542.7	663.4	8010	663.4	4172	60.86
28.0	47.8	47.8	277.0	649.7	1002	649.7	554.1	649.7	9286	649.7	4655	55.5
30.0	37.99	37.99	281.6	639.2	1042	639.2	563.2	639.2	10710	639.2	5166	50.0
32.0	30.16	30.16	285.3	630.9	1085	630.9	570.6	630.9	12360	630.9	5726	45.0
34.0	23.95	23.95	288.3	624.4	1130	624.4	576.5	624.4	14130	624.4	6348	40.0
36.0	18.98	18.98	290.6	619.3	1177	619.3	581.1	619.3	16080	619.3	7058	35.0
38.0	15.11	15.11	293.20	615.3	1227	615.3	585.1	615.3	18240	615.3	7812	30.0
40.0	12.00	12.00	30000	612.1	15000	612.1	588.1	612.1	21000	612.1	8700	25.0

Attenuator Networks.

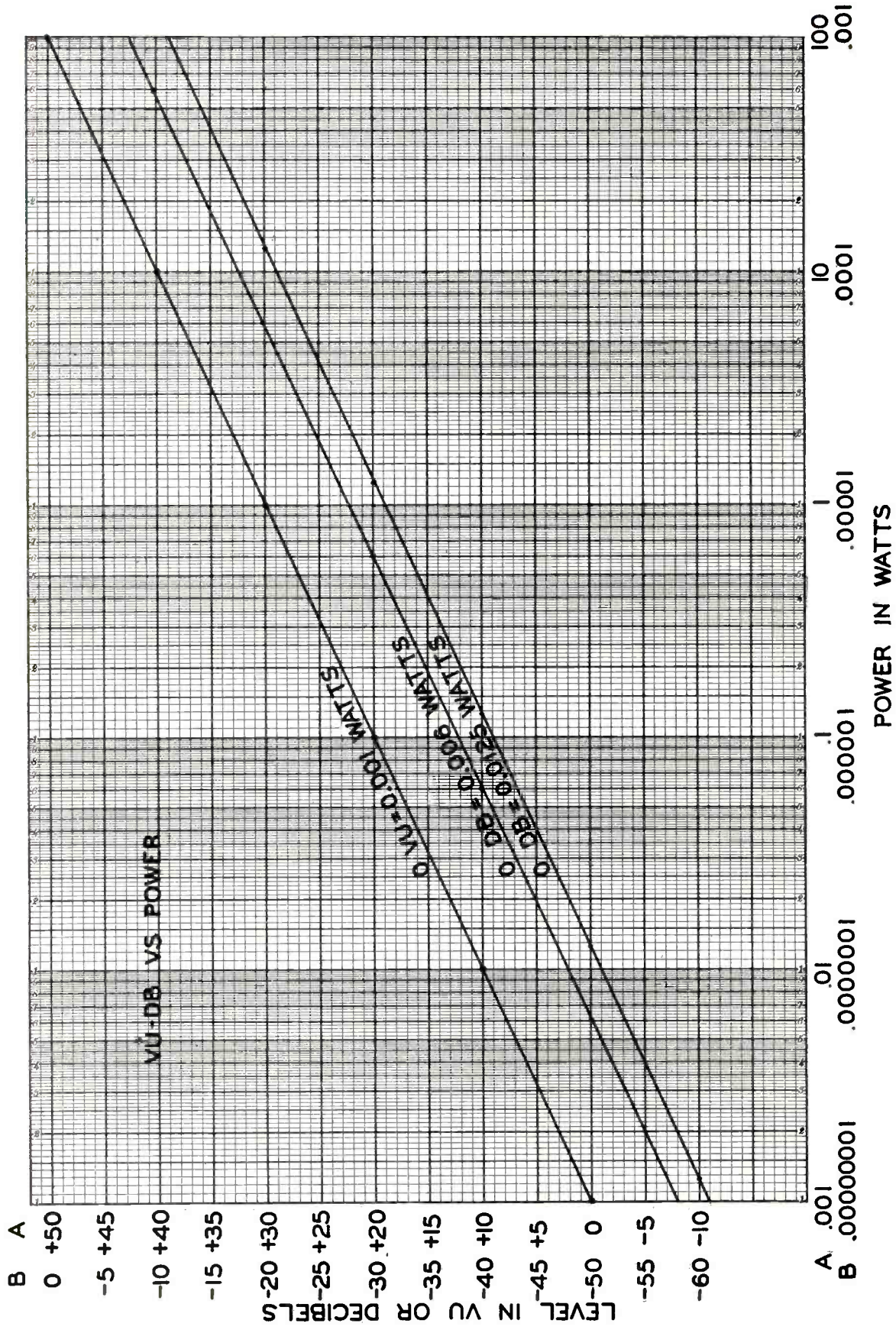



## MICROPHONES AND ACCESSORIES

Page	Type Number	Description	MI Number
5-6	.....	General Information, Microphones	
7-8	77-DX	Polydirectional Microphone .....	4045-F
7-8	77-DX	Polydirectional Microphone (TV Low Luster Gray) .....	11006-C
8	.....	Spare Zipper Bag (for 77-DX) .....	4087
9-10	BK-1A	Pressure Microphone .....	11007
11-12	BK-5A	Uniaxial Microphone .....	11010
12	.....	Boom Unit (for BK-5A) .....	11012
12	.....	Wind Screen (for BK-5A) .....	11011
12	.....	Cushion Mounting Assembly (for BK-5A) .....	Stock #93973
13-14	BK-6B	Miniature Dynamic Microphone .....	11017
15-16	SK-45	Pressure Microphone .....	12045-A
17-18	SK-35	Anti-Noise Velocity Microphone .....	12035
17-18	SK-46	Program Velocity Microphone .....	12046
<b>19-22                    Microphone Desk Stands</b>			
20	91-C	Desk Stand .....	4092-E
20	.....	Announce Stand 5/8"—27 Thread .....	4096-A
20	.....	Desk Stand .....	13240-A
21	.....	Pushmike Stand .....	6427
21	KS-11A	Desk Stand (for BK-1A) .....	11008
21	KS-5A	Desk Stand (for SK-46) .....	12066-B
22	.....	Flexible Microphone Stand, 13" .....	11745
22	.....	Flexible Microphone Stand, 19" .....	11746
22	.....	Flexible Stand Bracket .....	11747
<b>23-24                    Microphone Floor Stands</b>			
23	90-A	Deluxe Program Stand .....	4090-A
24	.....	Floor Stand, Stem 12071, Base 12072 .....	4068-D
24	.....	Three Section Floor Stand, Stem 12073, Base 12074 .....	6208
24	KS-2A	Portable Stand .....	4093-C
25	KS-3B	Boom Stand (6 ft. extended) .....	11056
26	.....	Boom Stand (18 ft. extended) .....	11070
27	.....	Boom and Perambulator (17 ft. extended) .....	26574
27	.....	Microphone Boom Only .....	26574-1
27	.....	Perambulator Only .....	26574-2
<b>28-30                    Microphone Accessories</b>			
28	UA-3-11	Female Plug for Microphone Extension Cable (mates with UA-3-12) .....	11061
28	UA-3-12	Male Plug for Microphone Cable (mates with UA-3-11 and UA-3-13) .....	11062
28	UA-3-13	Flush Mounting Receptacle (mates with UA-3-12) .....	11063
28	P3-CG-12S	Male Plug for Microphone Cords .....	4630-B
28	P3-35	Wall Receptacle for Male Plug P3-CG-12S .....	4624-A
28	P3-CG-11S	Female Plug for Microphone Extension Cords .....	4620-B
28	.....	Male Adaptor for Plug Connection .....	11069
28	XL-3-11	Female Connector for Extension Cord .....	12058
28	XLR-3-31	Female Microphone Receptacle .....	11088-B
28	XLR-3-32	Male Microphone Receptacle .....	11087-B
28	XLR-3-11C	Microphone Plug, Female .....	11090-A
28	XLR-3-12C	Microphone Plug, Male .....	11089-A
29	.....	Adaptor 1/2" Pipe Thread Stand to 1/8" Mike .....	12051
29	.....	Adaptor 1/2" Pipe Thread Stand to 5/8"—27 Mike .....	12053
29	.....	Adaptor 1/2" Pipe Thread Stand to W.E. 5/8"—24 Mike .....	11066-2
29	.....	Adaptor W.E. 5/8"—24 Stand to 1/2" Pipe Thread Mike .....	11066-3
29	.....	Adaptor 5/8"—27 Stand to 1/8" Pipe Thread Mike .....	6229
29	.....	Adaptor 5/8"—27 Stand to 1/2" Pipe Thread Mike .....	12055
29	.....	Adaptor 1/2" Pipe Thread Mike .....	11009
29	.....	Microphone Cable, Three Conductor, #20 A. W. G. .....	43-C
29	.....	Microphone Cable, Two Conductor, #16 A. W. G. .....	13307
29	.....	Microphone Cable, Two Conductor #24 A. W. G. .....	13322
30	.....	Interconnecting Cable, Shielded Pair, #20 A. W. G. Solid .....	33
30	.....	Interconnecting Cable, Shielded Pair, #22 A. W. G. Stranded .....	34



## MICROPHONES AND ACCESSORIES (Continued)

Page	Type Number	Description	MI Number
30	.....	Interconnecting Cable, Shielded Pair, #18 A. W. G. Stranded.....	35
30	.....	Interconnecting Cable, Shielded Pair, Cotton Braided Outer Cover #22 A. W. G. ....	13306
30	.....	Cable Hook .....	11099-A
30	.....	Cable Lacing Cord #6.....	11719-A

## CONSOLETTES

31-32	BC-3B	Standard Console	11641
32	.....	Tube Kit (for BC-3B).....	11486
32	.....	On-Air Light Relay.....	11702-A
33-34	BC-5A	Audio Console	11637
34	.....	Tube Kit (for BC-5A).....	11483
35-38	BC-6A	Dual-Channel Audio Console.....	11638
38	.....	Tube Kit (for BC-6A).....	11484
38	.....	Announce Booth Speaker Relay (for BC-6A).....	11748

## CUSTOM EQUIPMENT

39-42	.....	Custom Audio Equipment	
-------	-------	------------------------	--

## AMPLIFIERS

43	.....	RCA Broadcast Amplifiers	
44	BX-21A	Preamplifier Power Supply.....	11317
44	.....	Tube Complement (for BX-21A) .....	11479
45-46	BA-21A	Preamplifier and Isolation Amplifier.....	11244-A
46	.....	Tube Kit (for BA-21A).....	11482
47-48	BA-12A	Utility Amplifier .....	11232
48	.....	Tube Kit (for BA-12A).....	11287
48	.....	Receiver Type Tubes (for BA-12A).....	11287-A
49-50	BA-23A	Program Amplifier .....	11246-A
50	.....	Tube Kit (for BA-23A).....	11480
50	.....	Step Attenuator .....	11730-A
51-52	BA-24A	Monitoring Amplifier .....	11247
52	.....	Tube Kit (for BA-24A).....	11481
53-54	BA-25A	Automatic Gain Controlled Program Amplifier.....	11434
54	.....	Tube Kit (for BA-25A).....	11487
55-56	MC-60	Monitoring Amplifier (60-Watt).....	11236-B
55-56	MC-30	Monitoring Amplifier (30-Watt).....	11229-A
56	C-4	Preamplifier .....	.....
56	C-8	Preamplifier .....	.....
57-58	BA-6A	Limiting Amplifier .....	11225
58	.....	Tube Kit (for BA-6A).....	11289
58	.....	Shelf .....	11599
59-60	BN-5A	Single Channel Remote Amplifier.....	11249
60	.....	Tube Kit with Selected Input Stage and Voltage Amplifier (for BN-5A) .....	11485
60	.....	Tube Kit with Unselected Input Stage and Voltage Amplifier (for BN-5A) .....	11485-A
61-62	BN-6A	Transistor Portable Remote Amplifier.....	11221
62	.....	Canvas Carrying Case (for BN-6A).....	11377
62	.....	Input Transformer (30/150 ohms).....	11776
62	.....	Transistor Kit (for BN-6A).....	11777
62	.....	Step Type Attenuator for BN-6A Master Controls.....	11751-3
62	.....	Step Type Attenuator for BN-6A Fader Controls.....	11751-4
63	SA-10C	10-Watt Amplifier .....	12161
63	.....	Plug-In 200 Ohm Input Transformer.....	12399
63	.....	Plug-In 50 Ohm Input Transformer.....	12398

**AMPLIFIERS (Continued)**

Page	Type Number	Description	MI Number
64		<b>Amplifier Accessories</b>	
64	.....	Bridging Volume Controls (with knob for panel mounting).....	11278-E
64	.....	Bridging Volume Control (with screw-driver adjustments for chassis mounting).....	11278-F
64	.....	Simpson VU Meter.....	Stock #53064
64	.....	Multiple Pad for Calibrating the VU Meter to desired reference level.....	Stock #19328
64	.....	Zero Adjustment Pad.....	Stock #19327

**RACK EQUIPMENT**

65-66	BR-84A	Standard Cabinet Rack.....	30951-A84
65-66	BR-84B	Standard Cabinet Rack, less front door.....	30951-B84
65-66	BR-84C	Standard Cabinet Rack, less side panels.....	30951-C84
65-66	BR-84D	Standard Cabinet Rack, less side panels and front door.....	30951-D84
65-66	BR-84E	Standard Cabinet Rack, less side panels and front and rear doors.....	30951-E84
66	.....	Door (Non-Ventilated).....	30530-G84
66	.....	Side Panel.....	30541-G84
66	.....	Door (Ventilated).....	30535-G84
66	.....	Electrical Shield (for mid rack section).....	30546-G21
66	.....	Electrical Shield (for top and bottom rack sections).....	30546-G28
66	.....	Single Trim Strip.....	30566-G84
66	.....	Double Trim Strip.....	30568-G84
66	.....	Terminal Board Mounting Bracket.....	4570-A
66	.....	Audio Terminal Block.....	4569
66	.....	Power Terminal Strip.....	4568
66	.....	Set Terminal Board Mounting Angles.....	30527-G29
66	.....	Set Panel Mounting Angles.....	30526-G84
66	.....	Ground Bus Kit.....	11728
67	.....	<b>Rack Accessories</b>	
67	.....	1-23/32" Blank Panel, Umber Gray.....	4590-A
67	.....	3-15/32" Blank Panel, Umber Gray.....	4591-B
67	.....	5-7/32" Blank Panel, Umber Gray.....	4592-B
67	.....	6-31/32" Blank Panel, Umber Gray.....	4593-A
67	.....	8-23/32" Blank Panel, Umber Gray.....	4594-B
67	.....	10-15/32" Blank Panel, Umber Gray.....	4595-B
68	BR-19A	Cabinet Rack.....	11550
69	BJ-24	Jack Panel.....	11645
69	BJ-12	Jack Panel.....	11646
70	.....	Single BJ-24 Jack Strip Mat.....	11647-1
70	.....	Double BJ-24 Jack Strip Mat.....	11647-2
70	.....	Triple BJ-24 Jack Strip Mat.....	11647-3
70	.....	Patch Cord, 2-Foot Length.....	4652-2A & B
70	.....	Patch Cord, 4-Foot Length.....	4652-4A & B
70	.....	Patch Cord, 6-Foot Length.....	4652-6A & B
71	BR-22A	Mounting Shelf.....	11597
72	BR-2A	Panel, Umber Gray.....	11598-B
72	BR-2A	Shelf, Umber Gray.....	11599
73	BI-1B	Meter Panel.....	11388
73	57-D	Switch and Fuse Panel.....	4395-G
74	BI-5A	VU Meter Panel.....	11265-F
75	BE-21B	Variable Sound Effects Filter.....	11723
76	BE-2A	Line Equalizer.....	11752
77	.....	Line Transformer.....	11713
77	.....	Bridging Transformer.....	11712
78	.....	Fixed Pad (6 db) "H" Type.....	4171-29
78	.....	Fixed Pad (10 db) "H" Type.....	4171-30
78	.....	Balanced Two-Way 600 Ohm Dividing Network.....	11704
78	.....	Balanced Three-Way 600 Ohm Dividing Network.....	11704-A
78	.....	Balanced Four-Way 600 Ohm Dividing Network.....	11704-B

## RACK EQUIPMENT (Continued)

<i>Page</i>	<i>Type Number</i>	<i>Description</i>	<i>MI Number</i>
78	.....	Balanced Six-Way 600 Ohm Dividing Network.....	11704-D
78	.....	Balanced Bridge Pad.....	11705
79	.....	Regulated Power Supply.....	11316
80	.....	"On Air" Studio Warning Light.....	11706-1
80	.....	"Rehearsal" Studio Warning Light.....	11706-2
80	.....	"Audition" Studio Warning Light.....	11706-3
80	.....	"Standby" Studio Warning Light.....	11706-4
80	.....	"Silence" Studio Warning Light.....	11706-5
80	.....	Glass for Warning Lights.....	11718-1 to 5

## TURNTABLES

81-84	BQ-2B	Three-Speed Transcription Turntable (60 cycle).....	11833-B
81-84	BQ-2B	Three-Speed Transcription Turntable (50 cycle).....	11834-B
81-84	.....	Turntable Drive Assembly for BQ-2B (60 cycle).....	11830-B
81-84	.....	Turntable Drive Assembly for BQ-2B (50 cycle).....	11831-B
85-86	.....	Lightweight Tone Arm.....	11885-A
86	.....	1 Mil Fine Groove Pickup Head.....	11874-4
86	.....	2.5 Mil Standard Transcription Pickup Head.....	11874-5
87	.....	Pickup Equalizer .....	11888
88	.....	45 RPM Conversion Kit.....	11883
89	.....	45 RPM Record Adaptor.....	11886
90-91	BQ-101	Automatic Turntable (Sequential Selection).....	11840
90-91	BQ-102	Automatic Turntable (Random Selection).....	11841

## RECORDERS

92-93	SRT-2	Tape Record-Reproduce Chassis.....	12825
93	.....	Input Transformer .....	11776
93	.....	Output Transformer .....	11435
93	.....	Portable Carrying Case .....	11976

## TUNERS

94-95	ST-4	AM-FM Radio Tuner .....	12115-A
-------	------	-------------------------	---------

## SPEAKERS AND ACCESSORIES

96	.....	Loudspeaker Information and Quick Selection Chart	
97-100	LC-1A	15-Inch Speaker Mechanism.....	11411-A
99	.....	Power Attenuator (for LC-1A).....	11708-A
101	SL-12	12-Inch Speaker Mechanism.....	12458
102	SL-123	12-Inch Speaker Mechanism.....	12654
103	.....	12-Inch Speaker Mechanism.....	12418-B
104	.....	10-Inch Speaker Mechanism.....	11408
105	.....	10-Inch Speaker Mechanism.....	6333-D
106	.....	8-Inch Speaker Mechanism .....	12454
106	.....	8-Inch Speaker Mechanism (less transformer).....	12454-A
107	.....	Floor Console Cabinet for LC-1A Speaker (Blond).....	12464-B
107	.....	Floor Console Cabinet for LC-1A Speaker (Mahogany).....	12464-M
107	.....	Floor Console Cabinet for SL-12 or 123 Speaker (Mahogany).....	12463-M
108	.....	Wall Speaker Housing for LC-1A.....	11406
109	.....	Wall Speaker Housing for 12" or 10" Speaker Mechanisms.....	11407-A
110	.....	Wall Speaker Housing for 12" and 10" Speaker Mechanisms.....	13253
110	.....	Reducing Baffle to Mount 10" Speaker Mechanism.....	13245-A
111	.....	Wall Speaker Housing for 8" Speaker Mechanism.....	6104
112	.....	Line Matching Speaker Transformer (16 watt).....	12368
112	.....	Matching Transformer (8 watt).....	12369
112	.....	Matching Transformer (8 watt Single Winding).....	11731



**INTERCOM EQUIPMENT**

113-114	.....	<b>Interphone Equipment</b>	
113-114	.....	Interphone Connection Unit.....	11734
113-114	.....	Retardation Coil .....	11737
113-114	.....	Shelf for Interphone Connection Unit.....	11735
113-114	.....	Panel for 14 Retardation Coils.....	11736-A
113-114	.....	Single Headband Assembly.....	11743
113-114	.....	Double Headband Assembly.....	11744
115	.....	Single Headphone (9K ohms impedance).....	11749
115	.....	Double Headphone (24K ohms impedance).....	11750
116-119		<b>Office Intercom Equipment</b>	
116-119	.....	6 Key Master Non Annunciator Multi-Com.....	14760
116-119	.....	12 Key Master Non Annunciator Multi-Com.....	14761
116-119	.....	24 Key Master Non Annunciator Multi-Com.....	14762
116-119	.....	48 Key Master Non Annunciator Multi-Com.....	14763
116-119	.....	7 Key Master Annunciator Multi-Com.....	14764
116-119	.....	13 Key Master Annunciator Multi-Com.....	14765
116-119	.....	25 Key Master Annunciator Multi-Com.....	14766
116-119	.....	49 Key Master Annunciator Multi-Com.....	14776
116-119	.....	7 Key Master Annunciator (Deluxe) Multi-Com.....	14767
116-119	.....	13 Key Master Annunciator (Deluxe) Multi-Com.....	14768
116-119	.....	23 Key Master Annunciator (Deluxe) Multi-Com.....	14769
116-119	.....	47 Key Master Annunciator (Deluxe) Multi-Com.....	14777
116-119	.....	1 Button (All Systems) Remote Units.....	14759
116-119	.....	1 Button (Deluxe) Remote Units.....	14775
116-119	.....	5 Button Multiple Remote Unit.....	14758

**TEST EQUIPMENT**

120-121	WM-71A	Distortion and Noise Meter.....	30071-A
122-123	WA-28A	Audio Push Button Oscillator.....	30028-A
124-125	BI-11A	Transmission Measuring Set.....	11350

**AUDIO DATA SECTION**

126-127	.....	Recommended Audio Wiring Practices
128-130	.....	Audio Data Section

**RCA REGIONAL  
OFFICES**

**Atlanta 3, Ga.**

522 Forsyth Bldg., Jackson 4-7703

**Boston 16, Mass.**

200 Berkeley Street, Hubbard 2-1700

**Camden 2, N. J.**

Front & Cooper Streets, Woodlawn 3-8000

**Chicago 54, Ill.**

1186 Merchandise Mart Plaza, Delaware 7-0700

**Cleveland 15, Ohio**

1600 Keith Bldg., Cherry 1-3450

**Dallas 35, Texas**

7901 Freeway #183, Fleetwood 2-3911

**Hollywood 28, Calif.**

1560 N. Vine Street, Hollywood 9-2154

**Kansas City 6, Mo.**

1006 Grand Avenue, Harrison 1-6480

**New York 20, N. Y.**

36 W. 49th Street, Judson 6-3800

**San Francisco 2, Calif.**

420 Taylor Street, Ordway 3-8027

**Seattle 4, Wash.**

2250 First Avenue, South, Main 8350

**Washington 6, D. C.**

1625 K Street, N. W., District 7-1260



Form AM-11856

**RADIO CORPORATION OF AMERICA**  
**BROADCAST & TELEVISION EQUIPMENT** **CAMDEN, NEW JERSEY**

Tmk(s) ®

PRINTED  
IN  
U.S.A.